

A

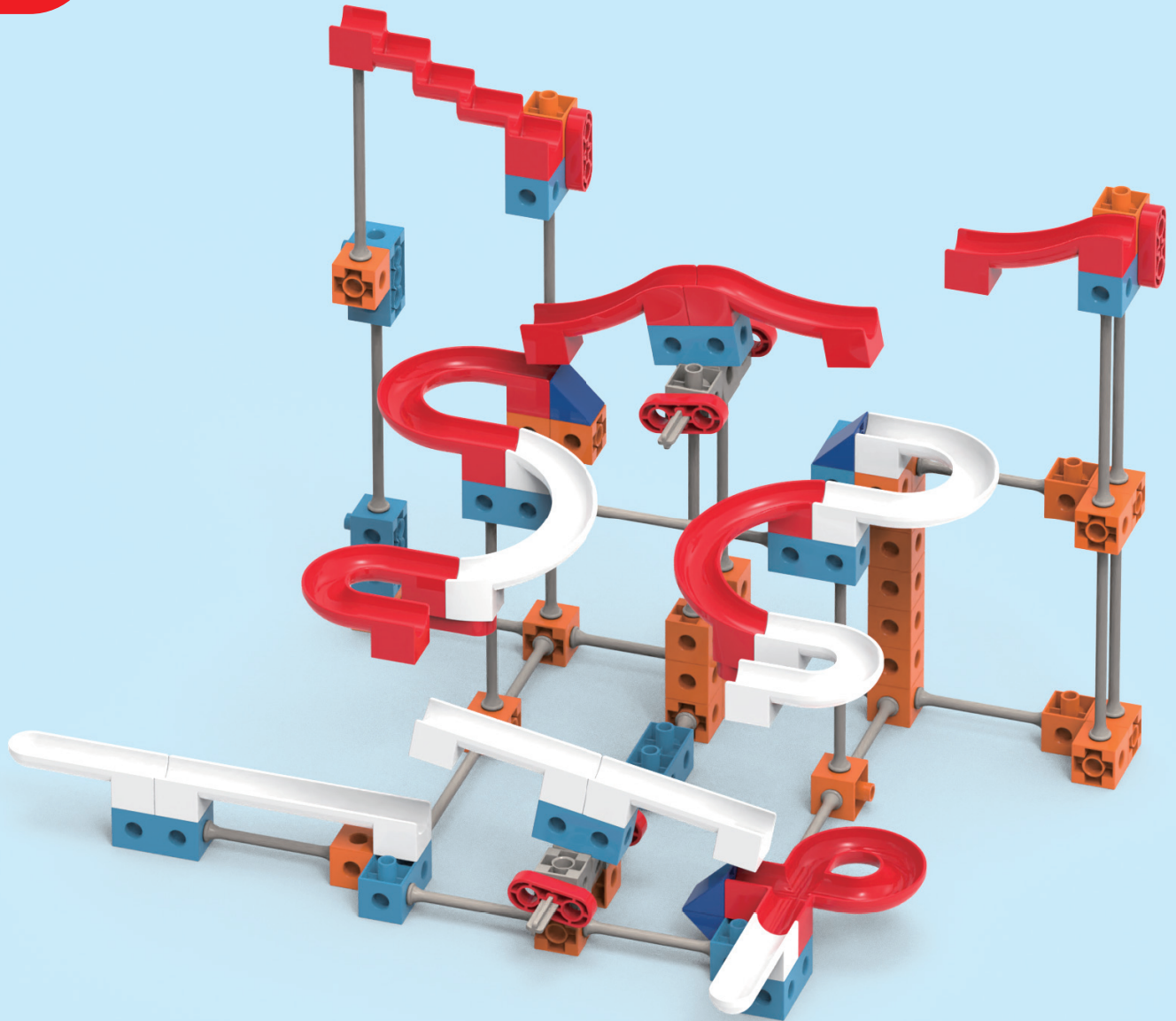

Parts List

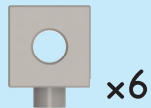

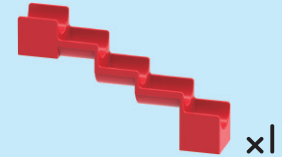
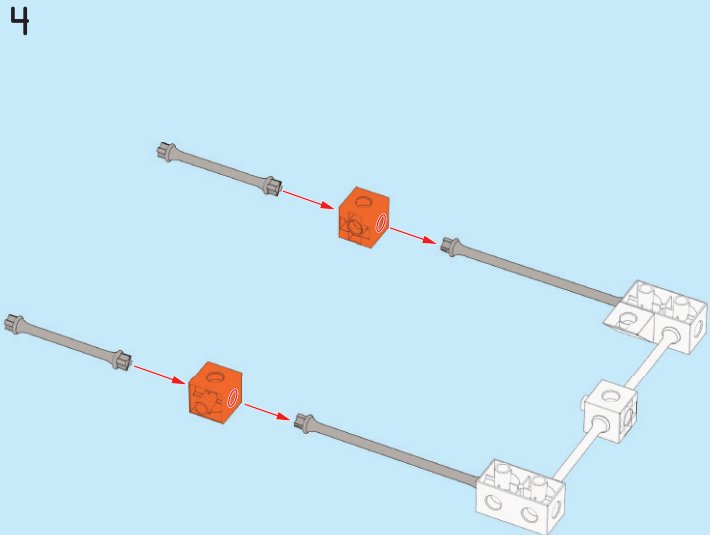
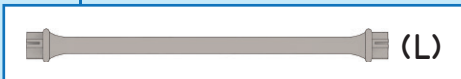
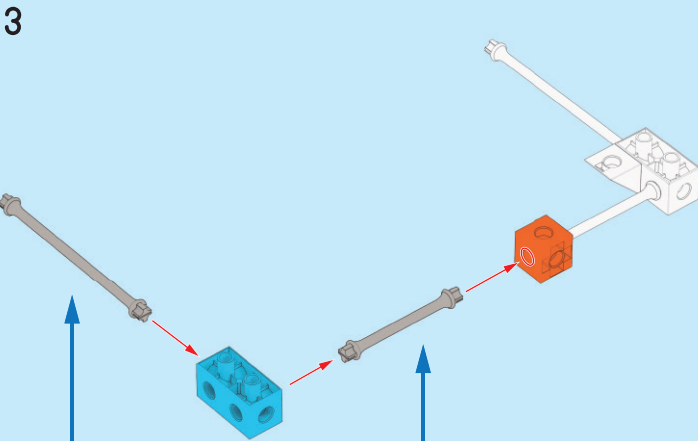
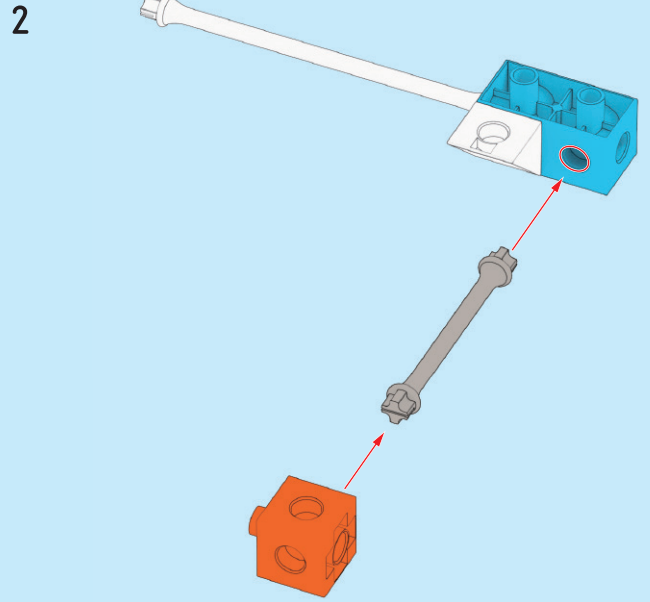
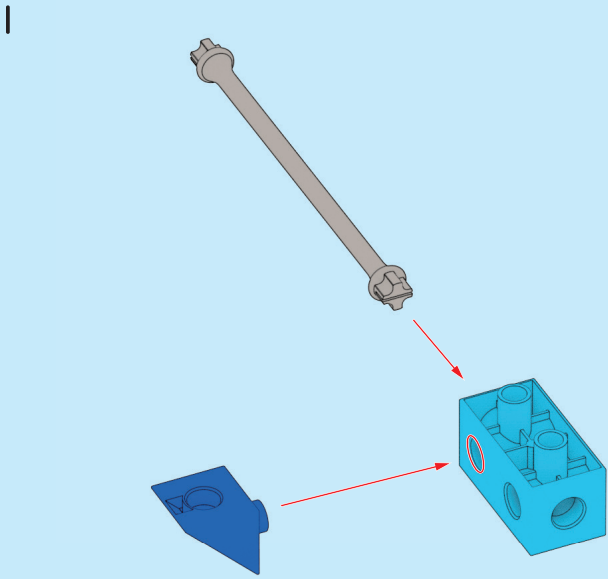

5

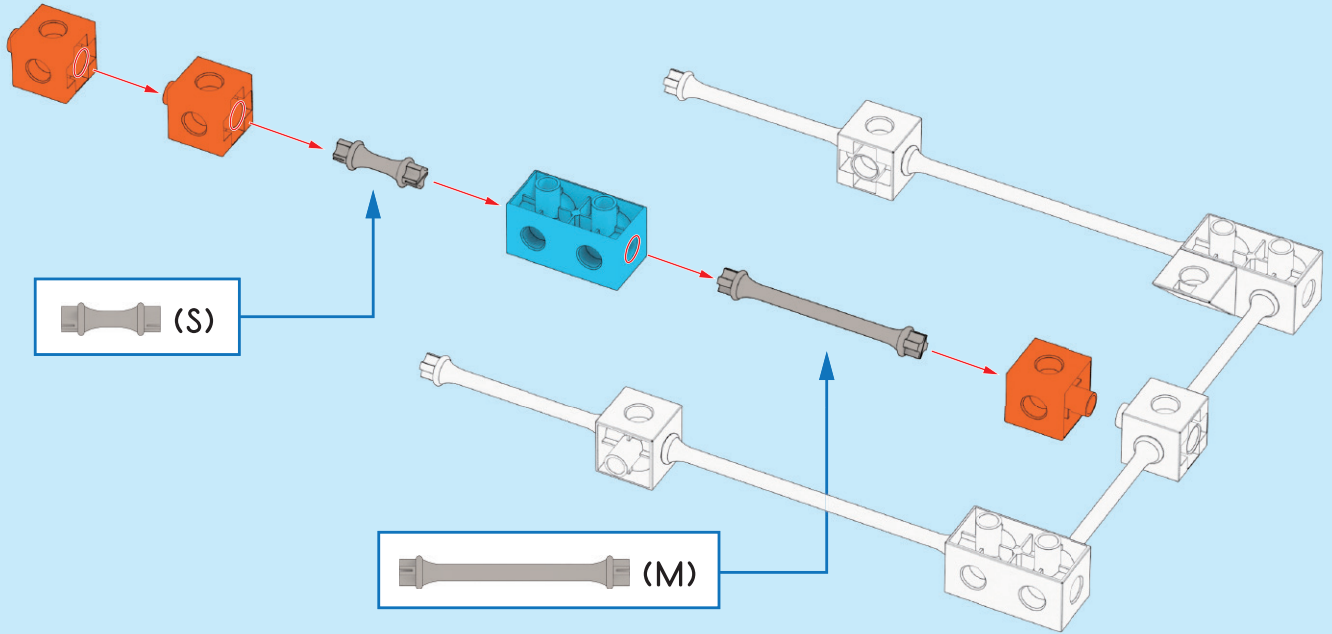

6

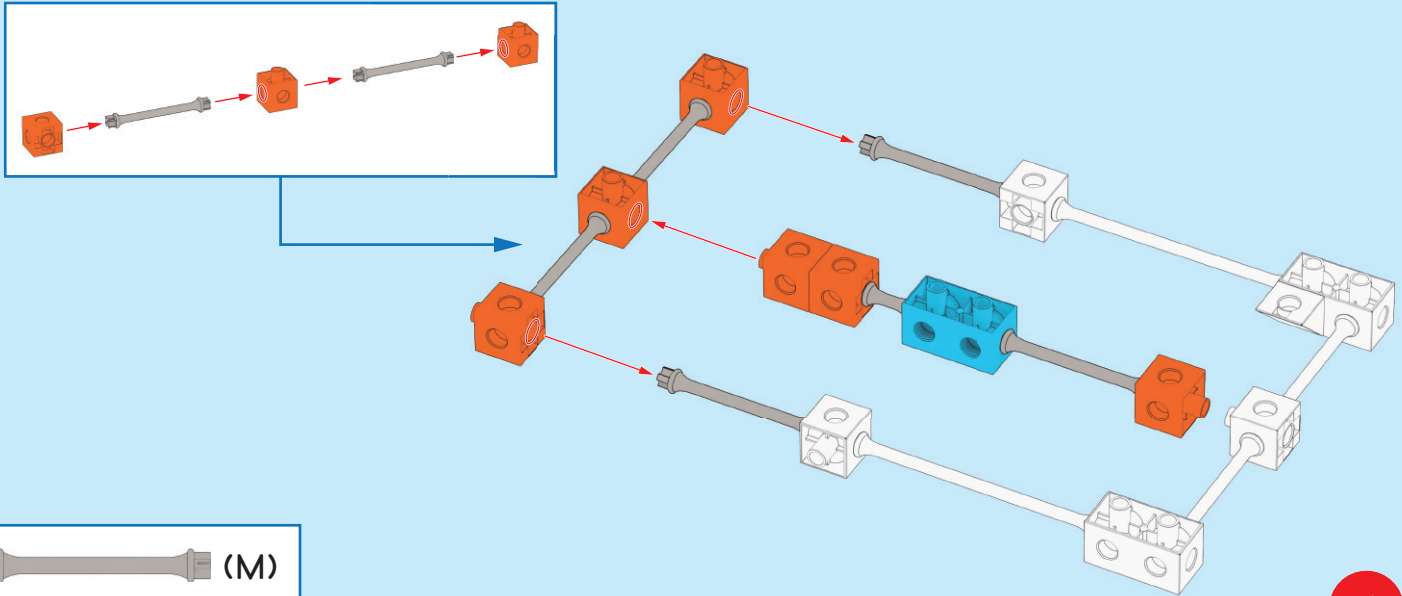

7

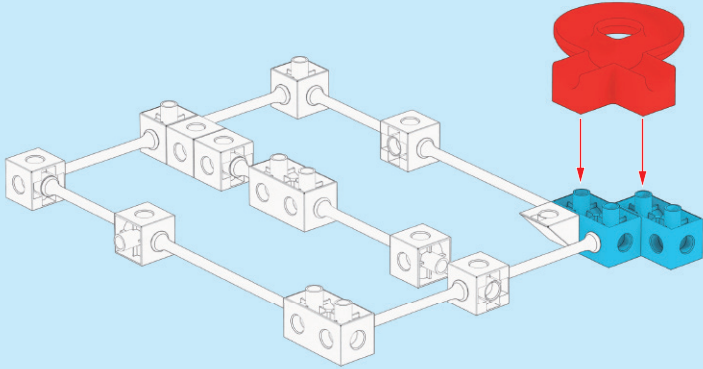
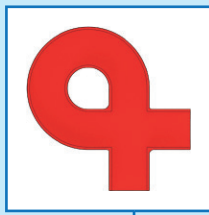

8

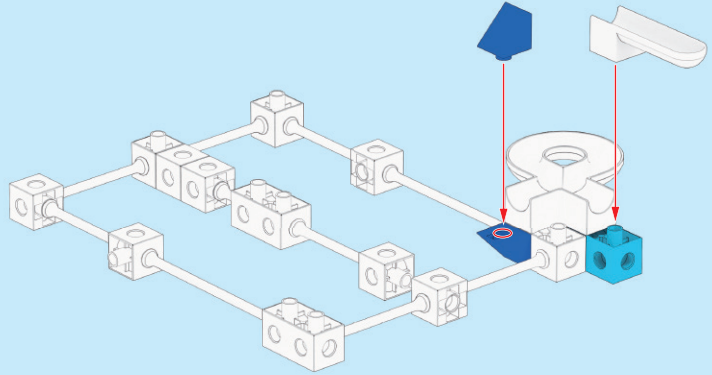
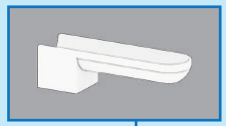

9

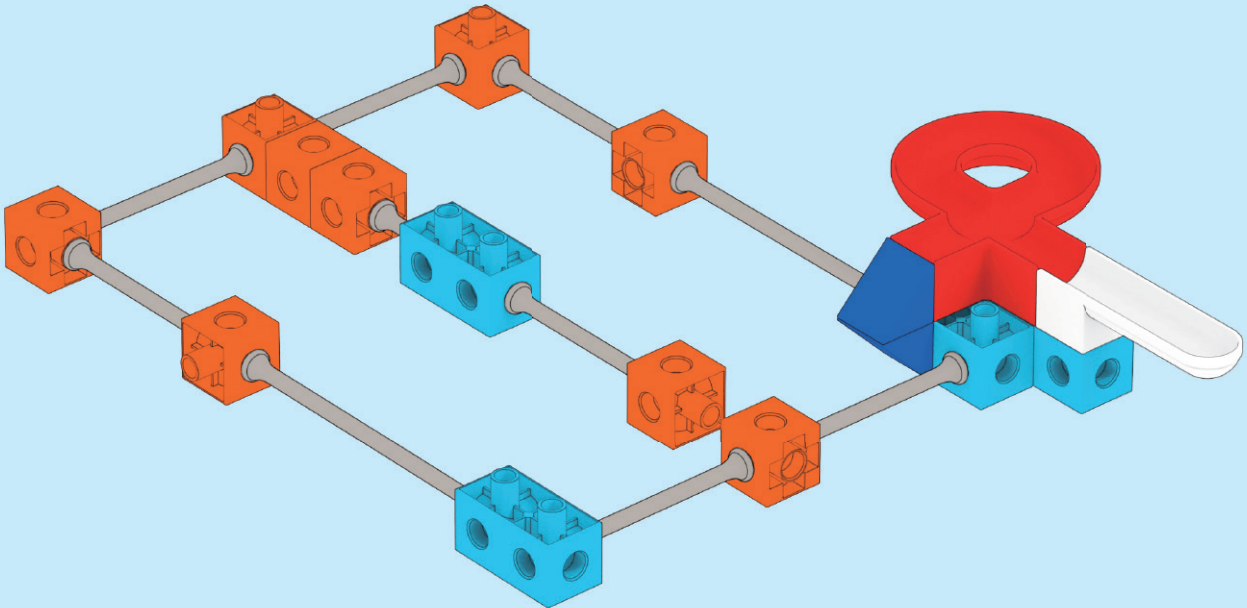

10

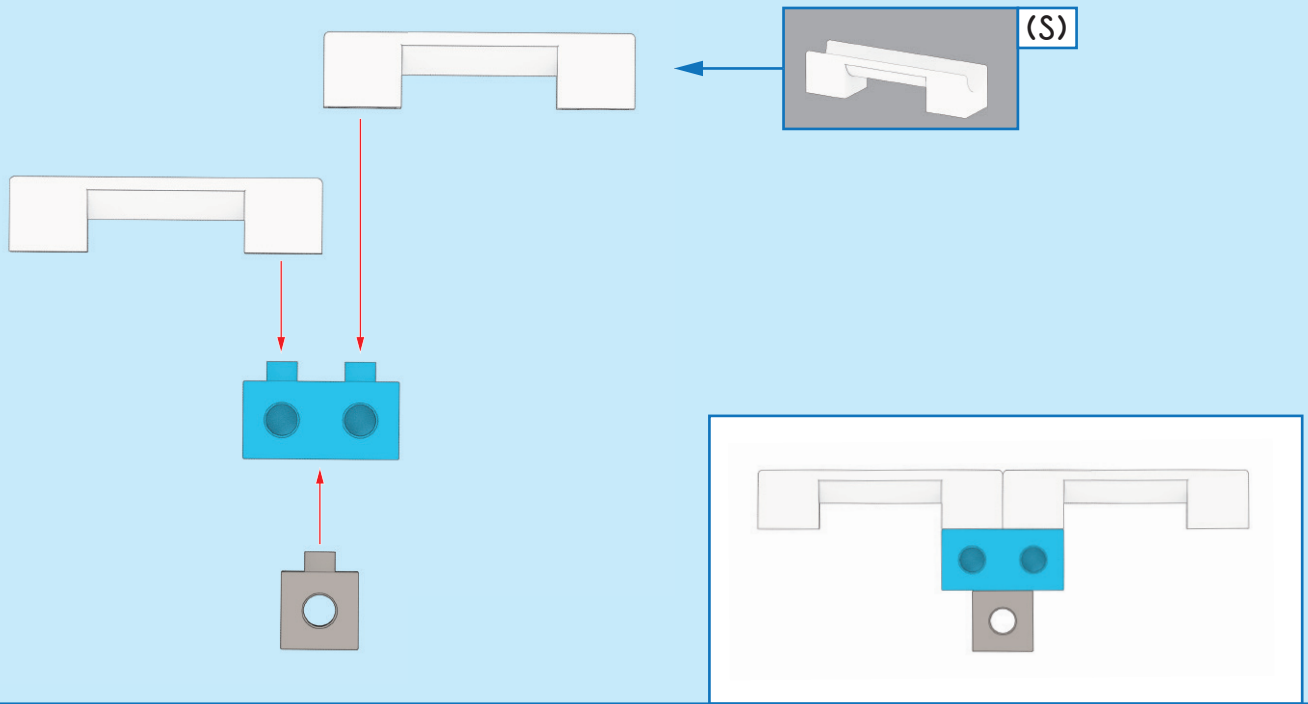

11

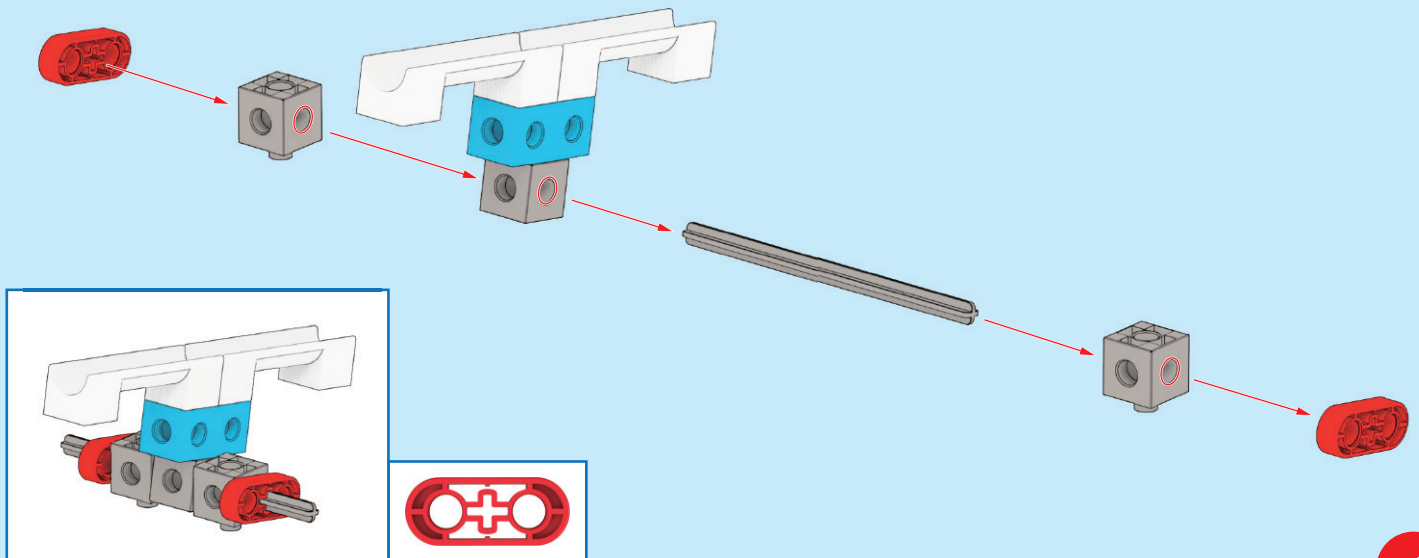

12

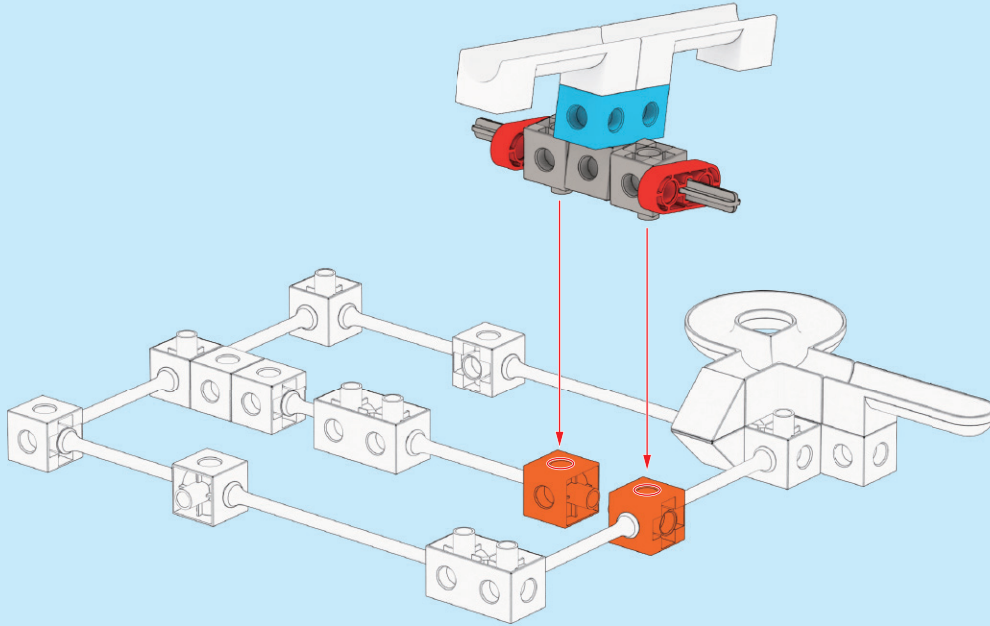

13

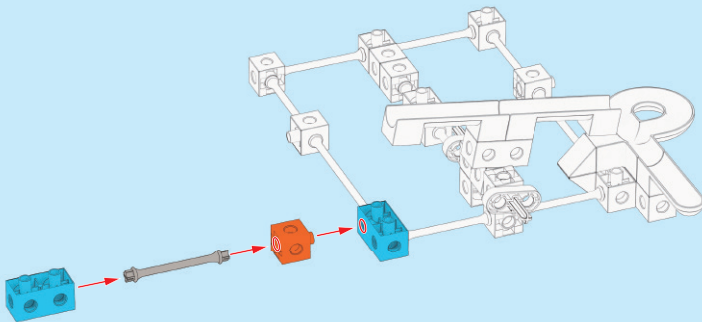

14

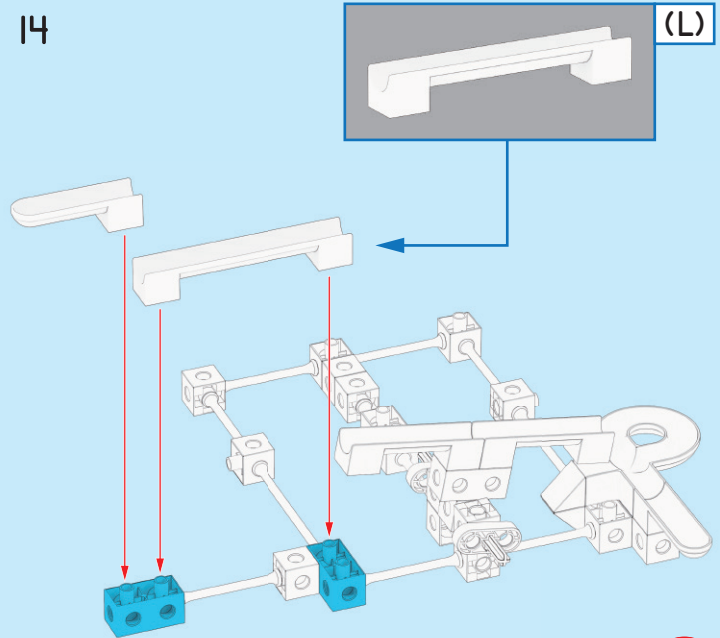

15

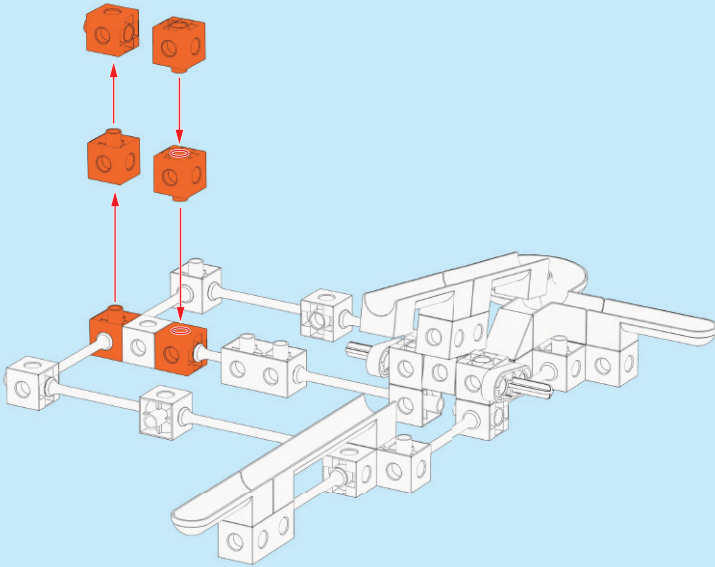

16

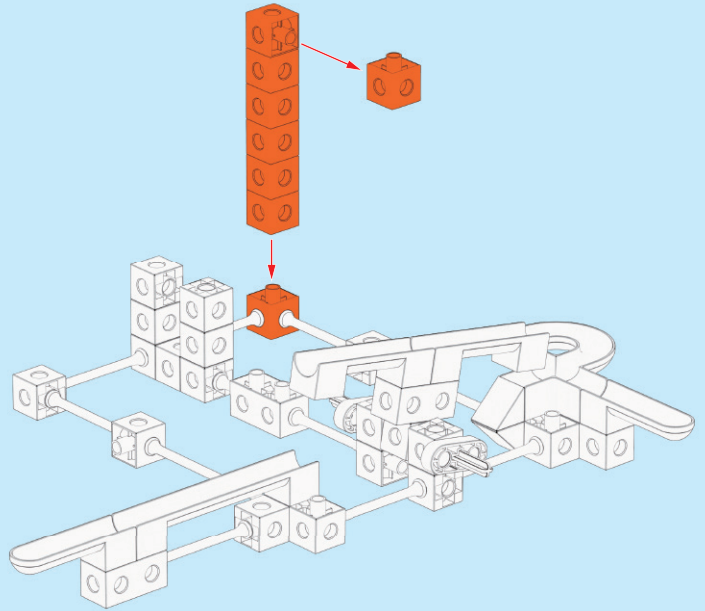

17

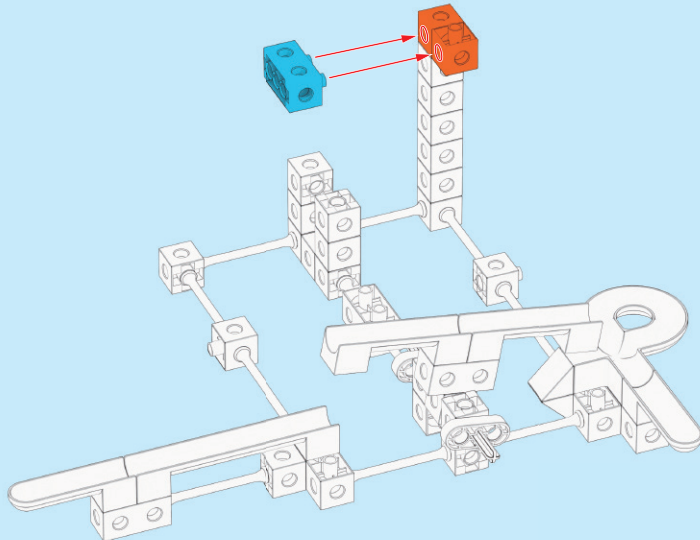

18

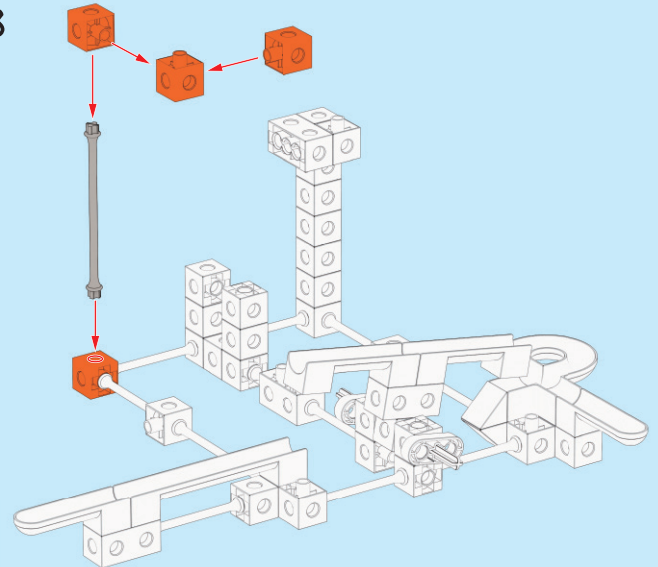

19

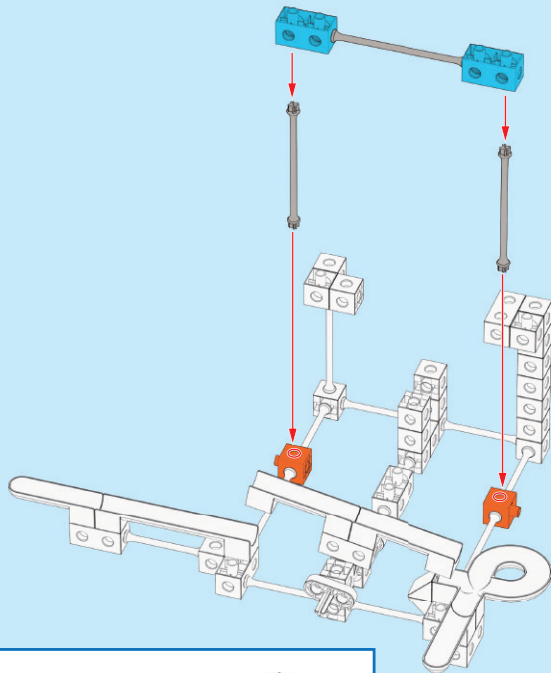

20

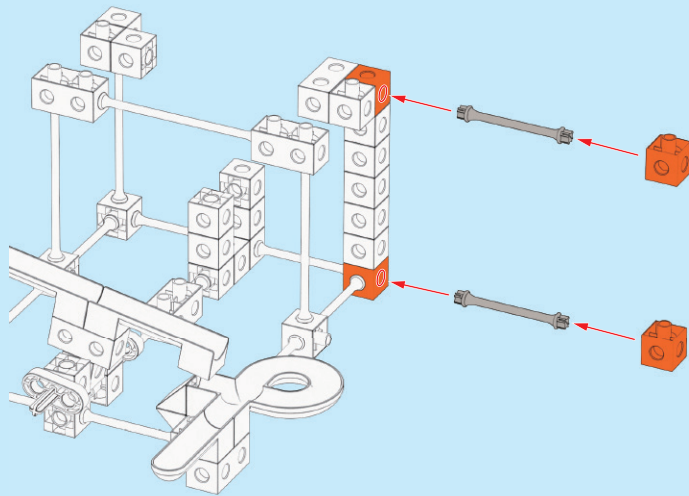

21

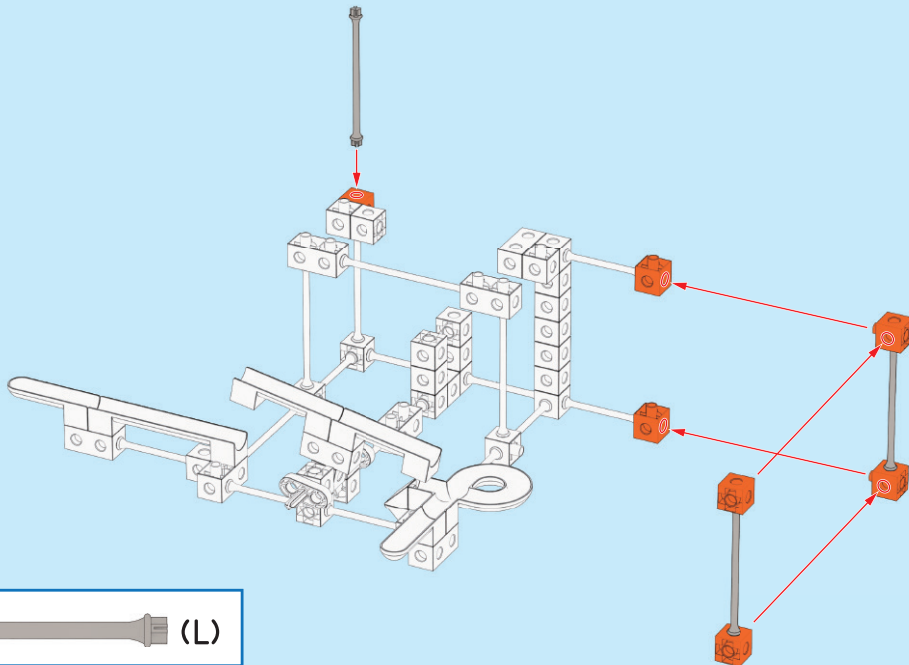

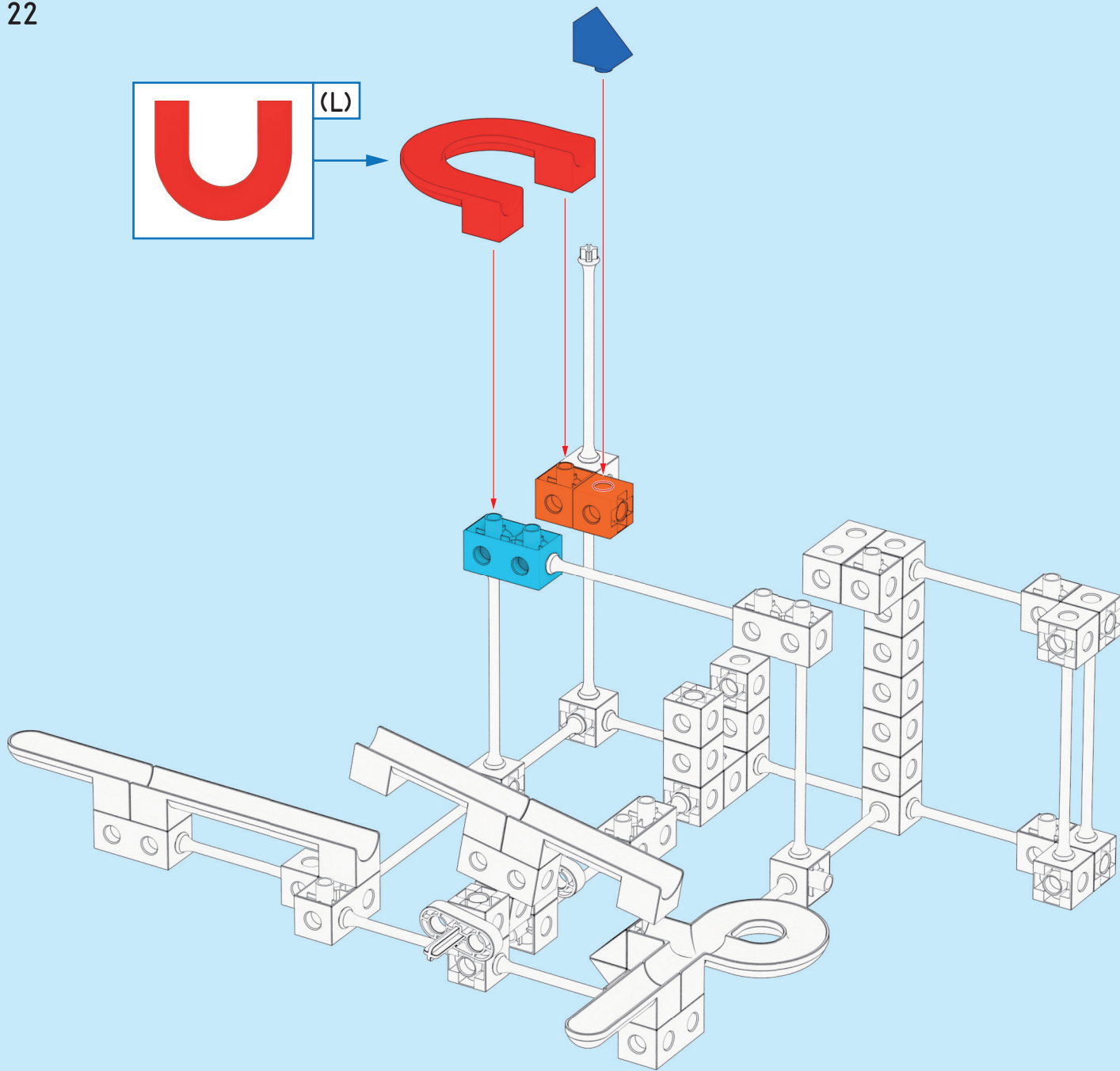
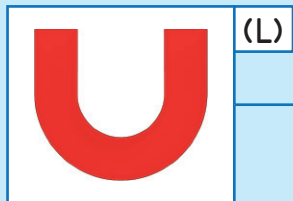

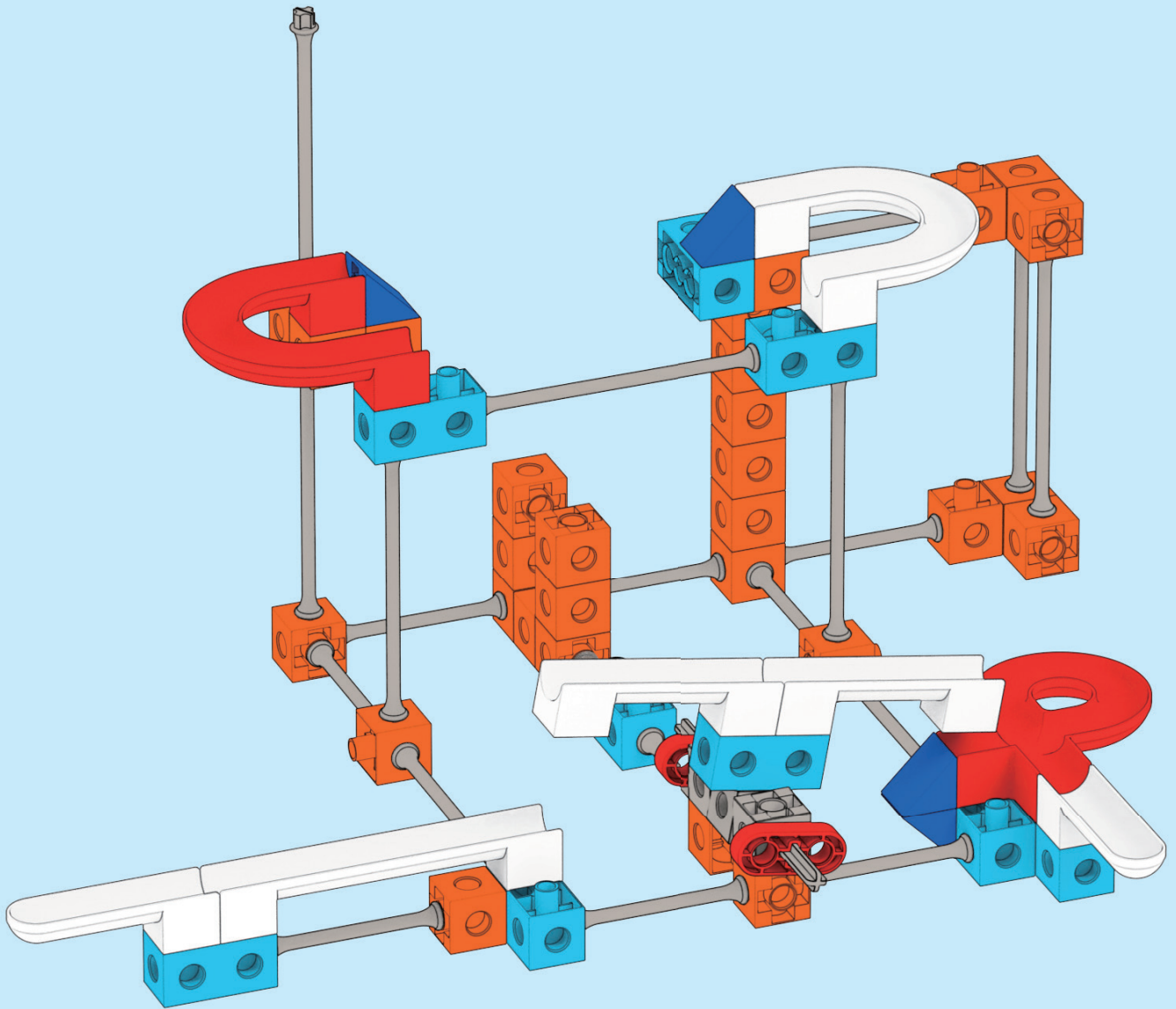

25

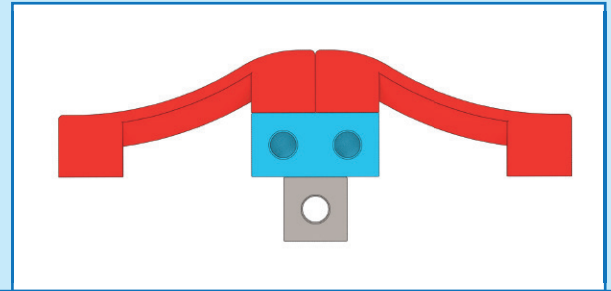
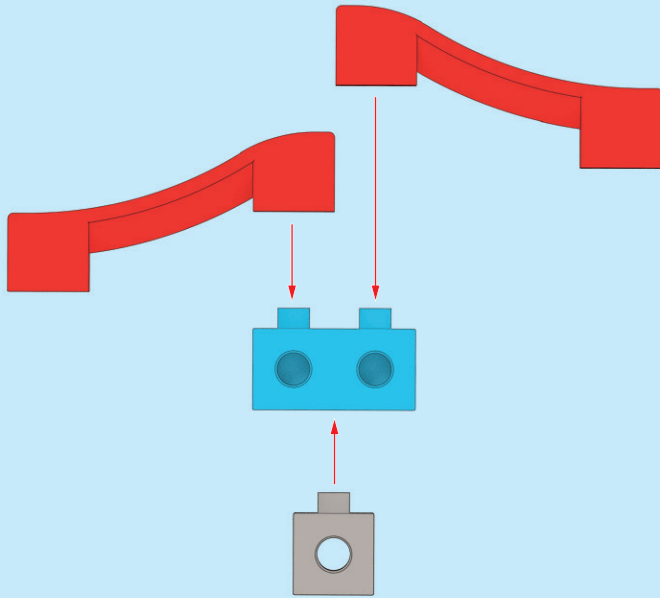

26

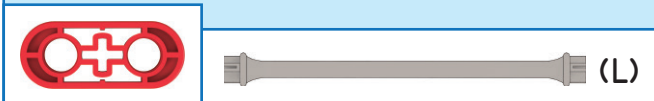
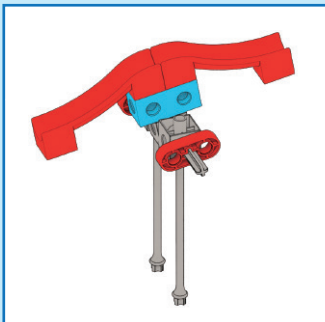
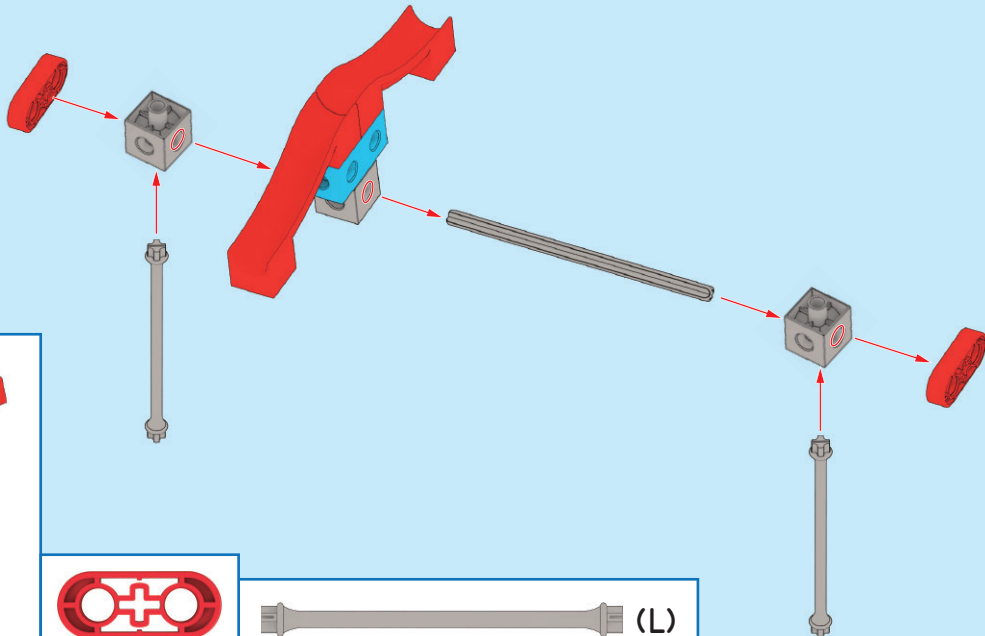

27

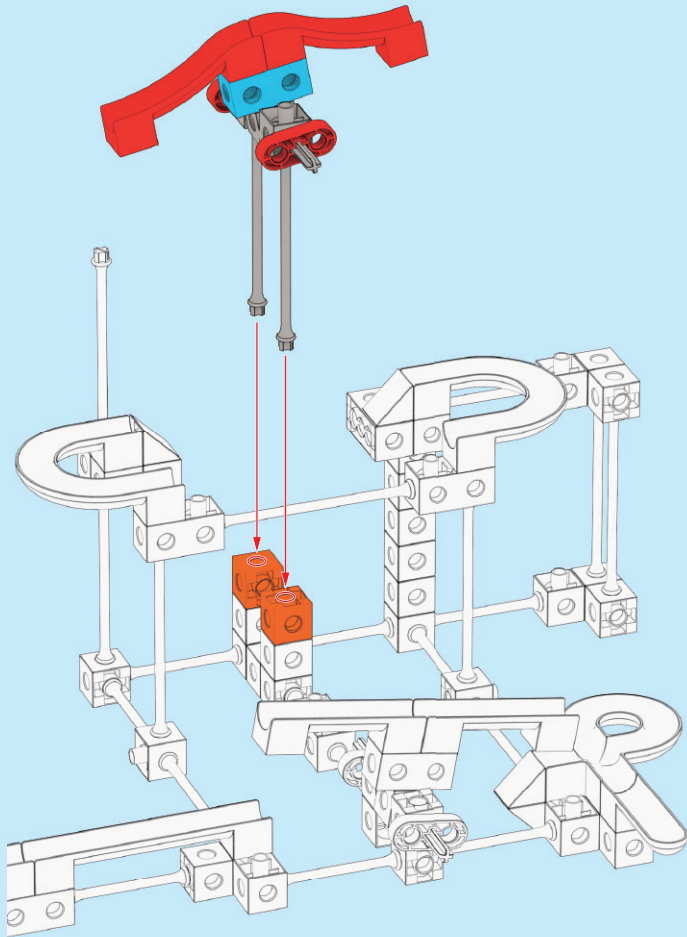

28

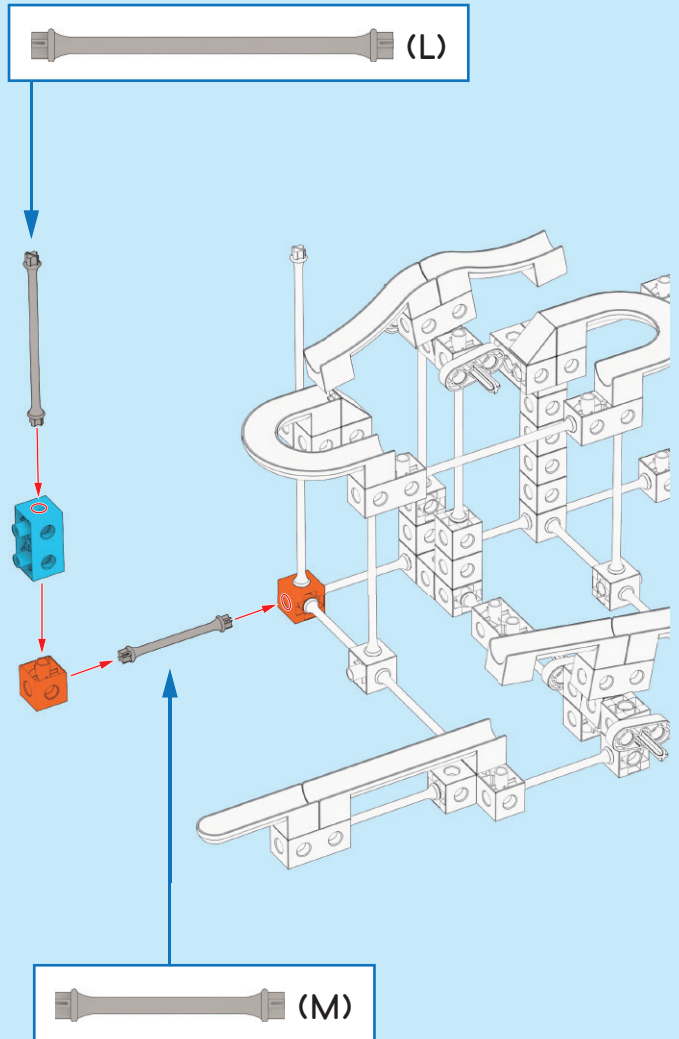

29

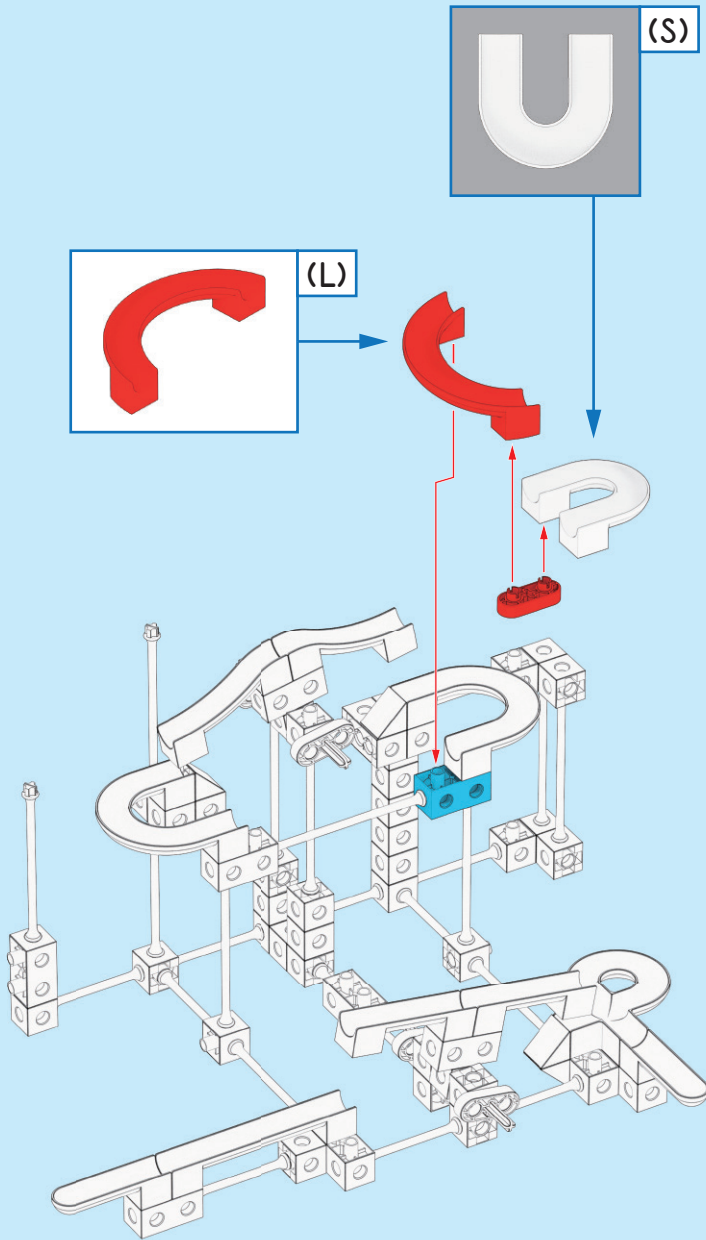

30

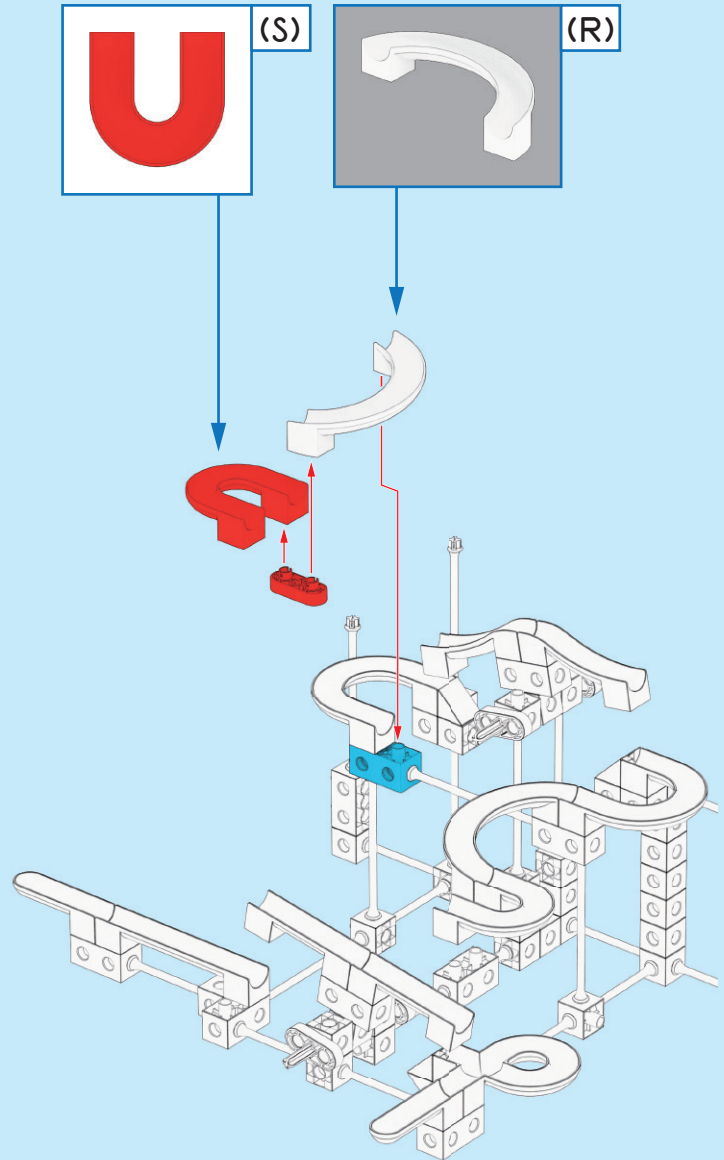

31

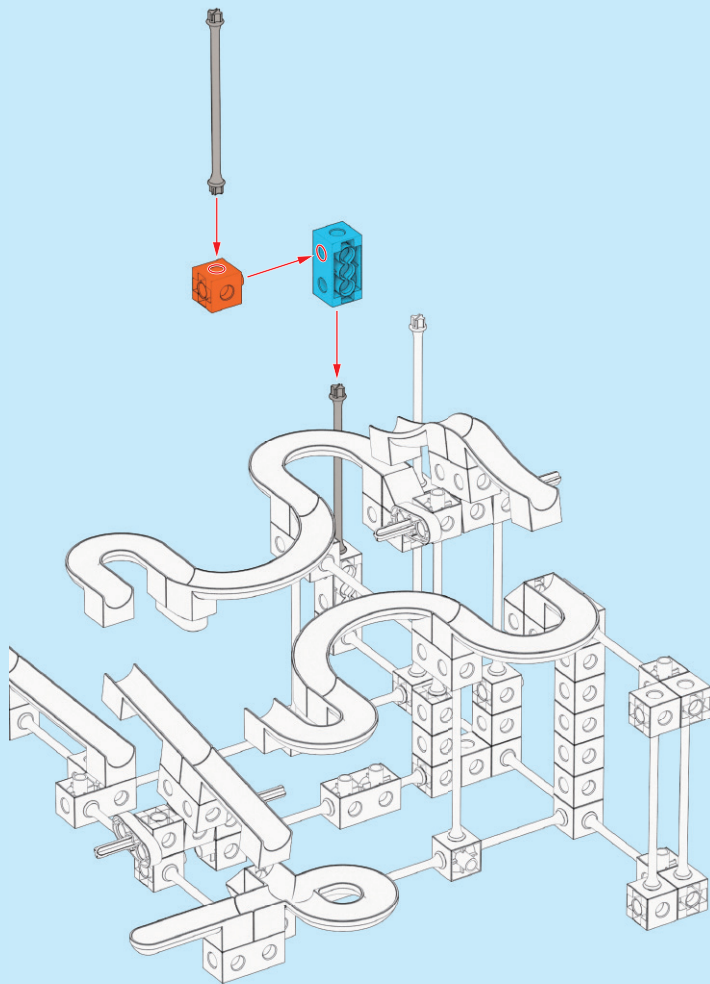

32

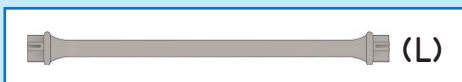
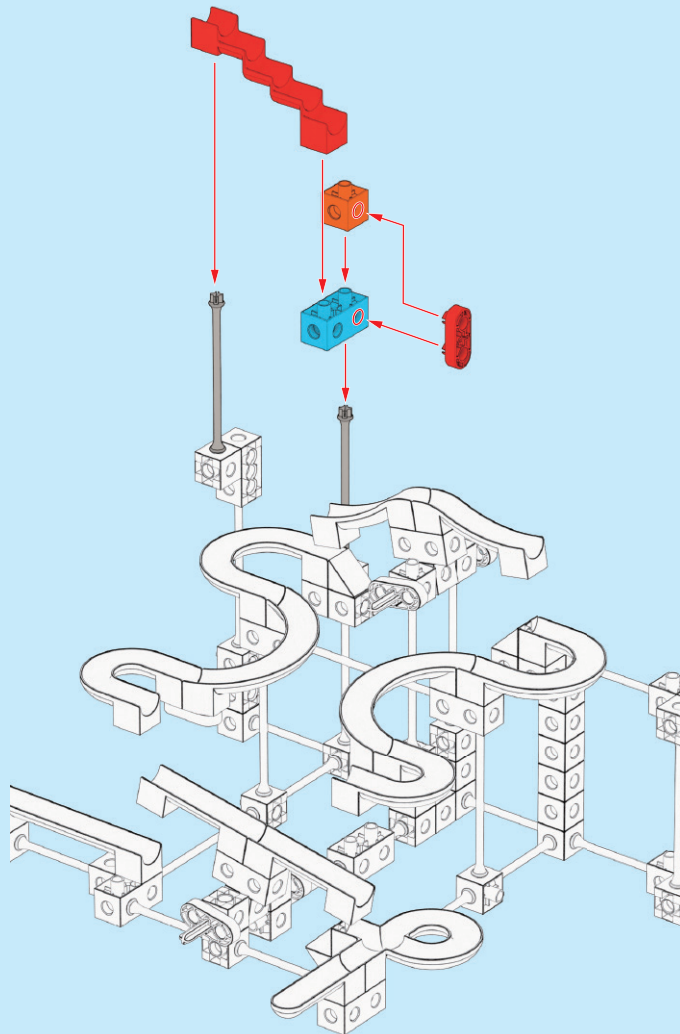

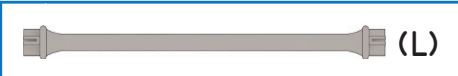
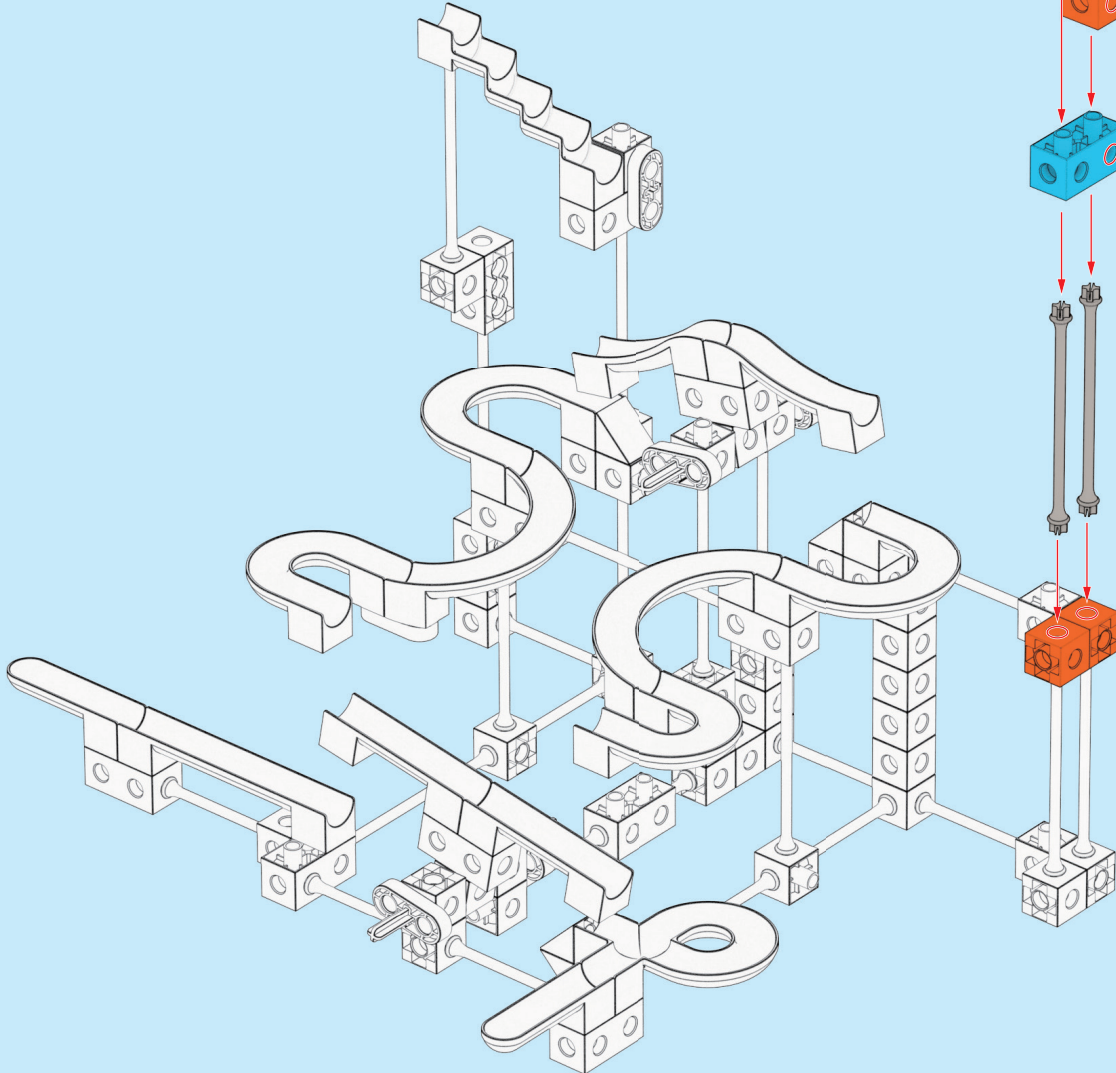
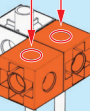
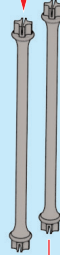
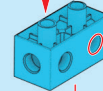
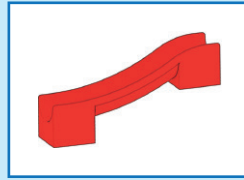

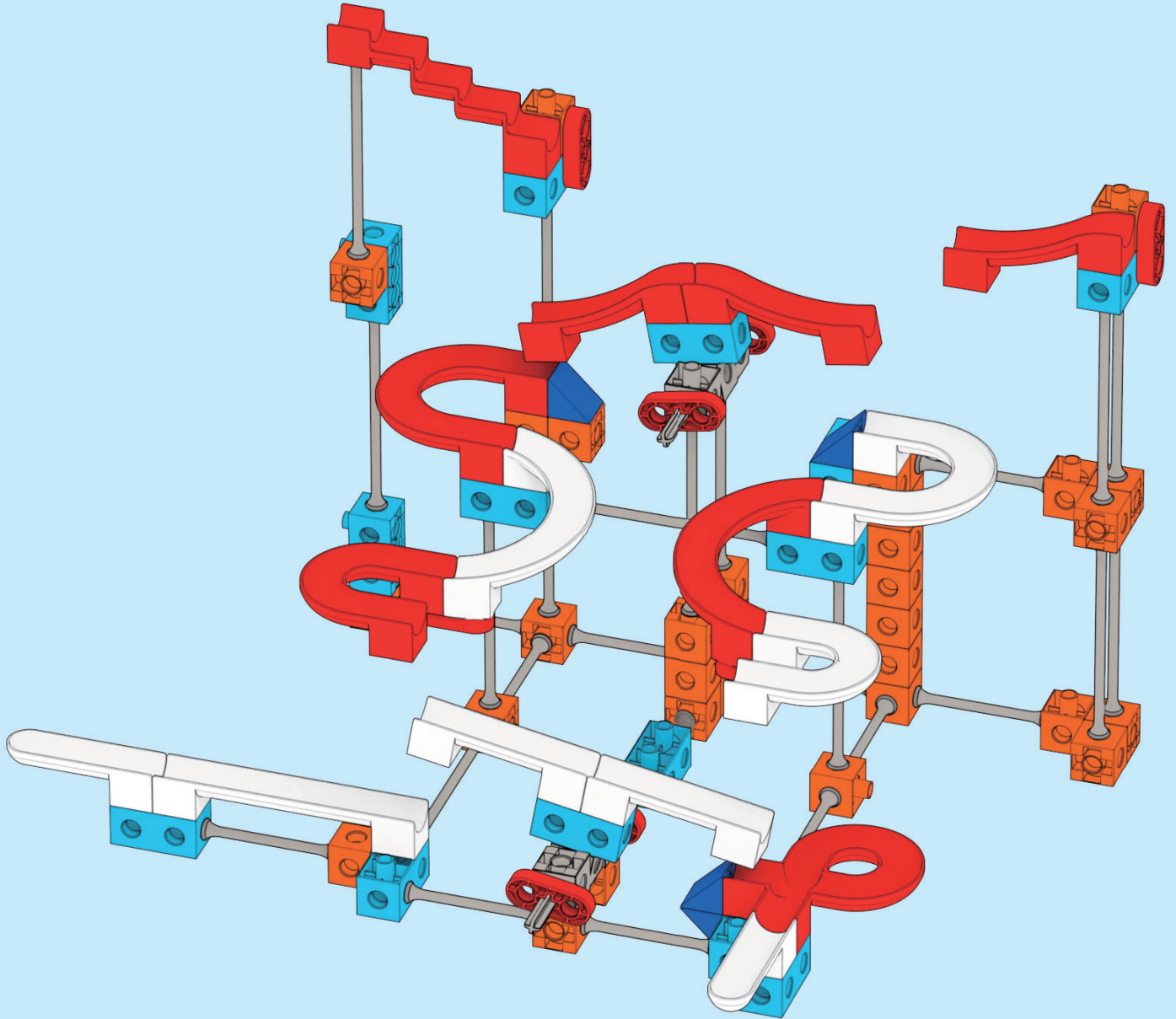

B



Parts List

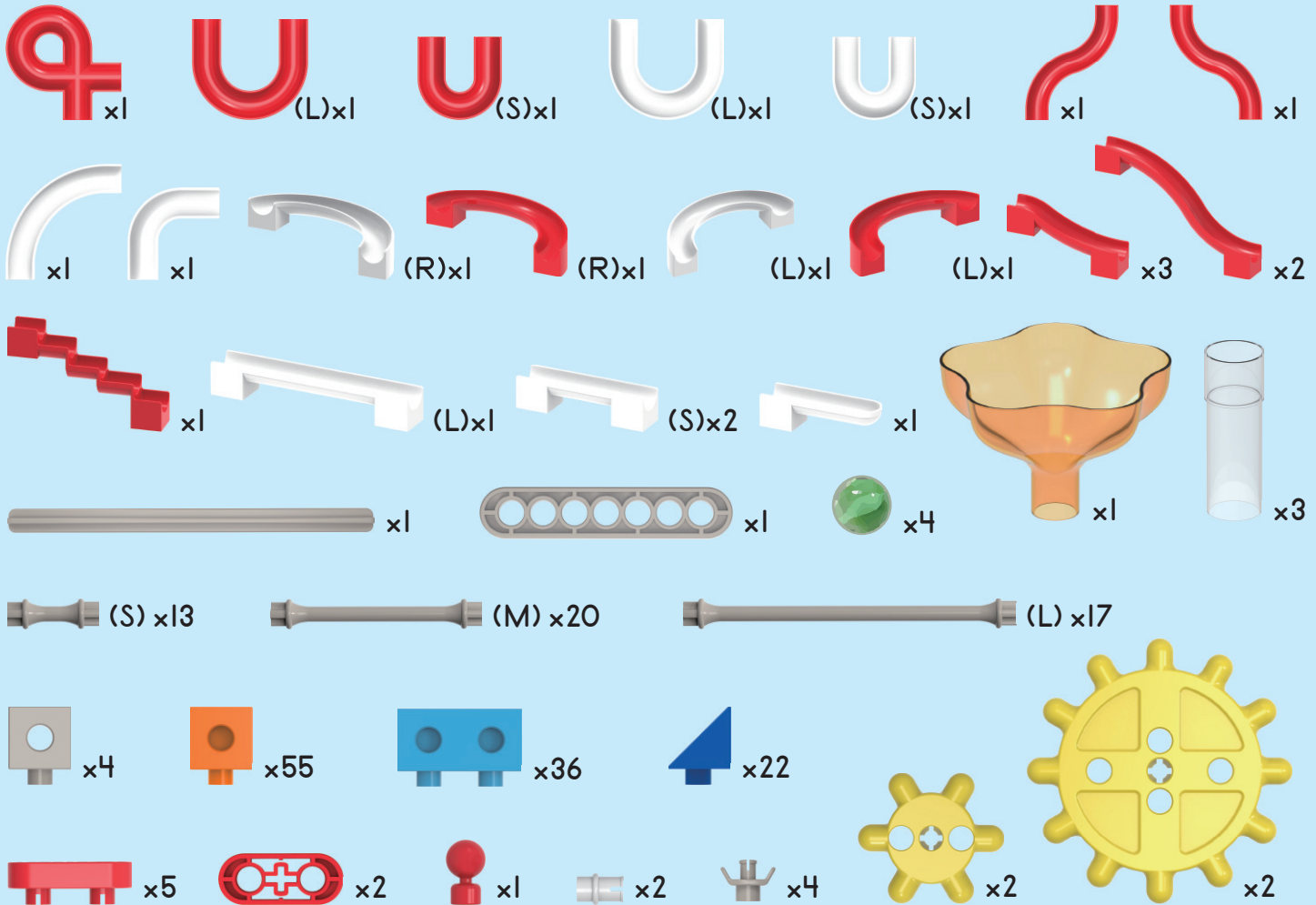

Helpful Tips

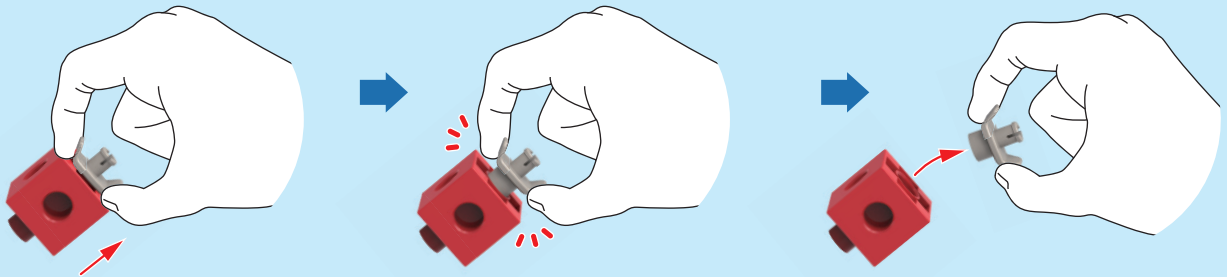
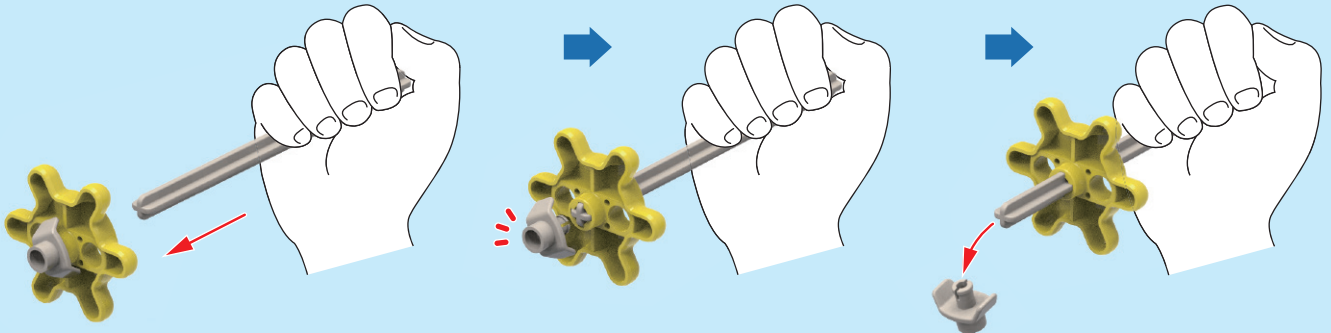

1

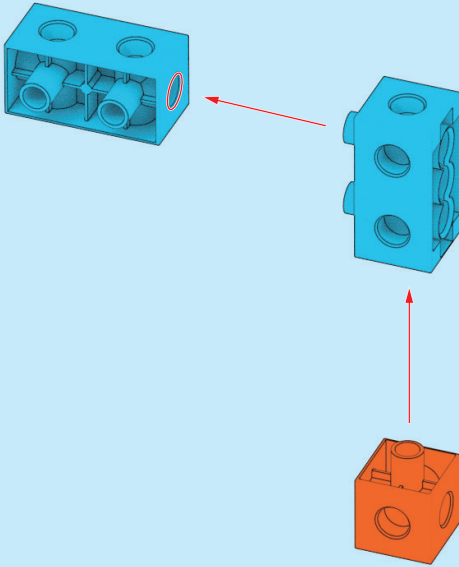

2

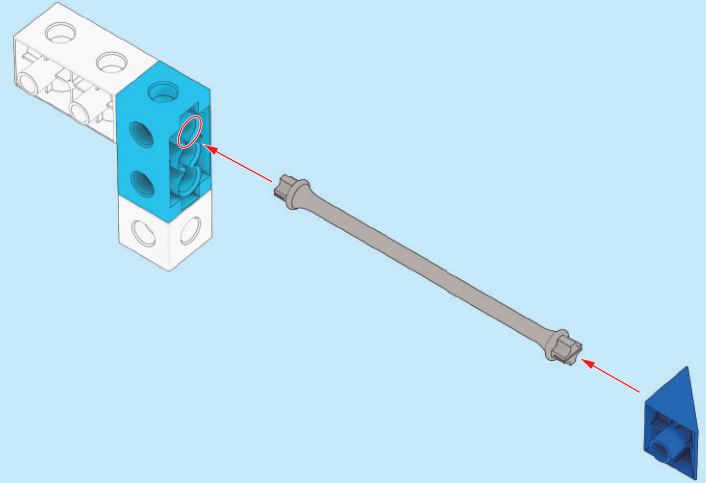

3

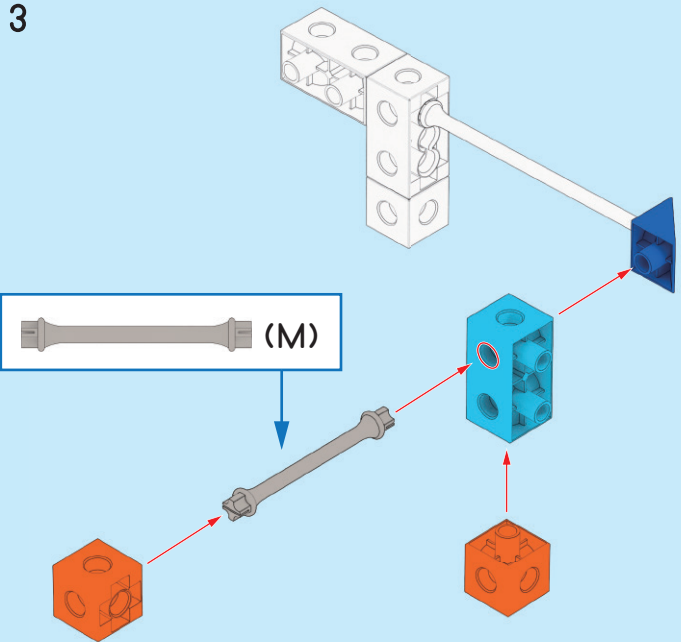

4

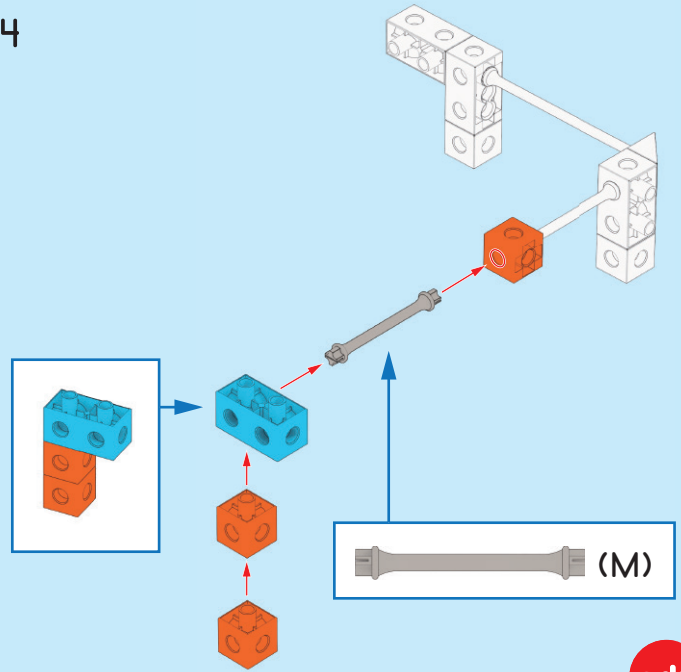

5

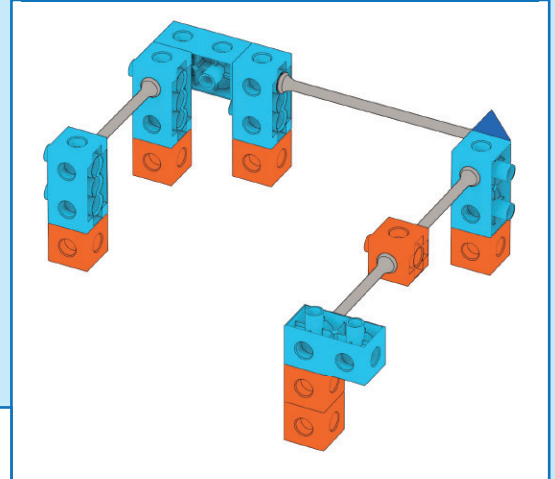
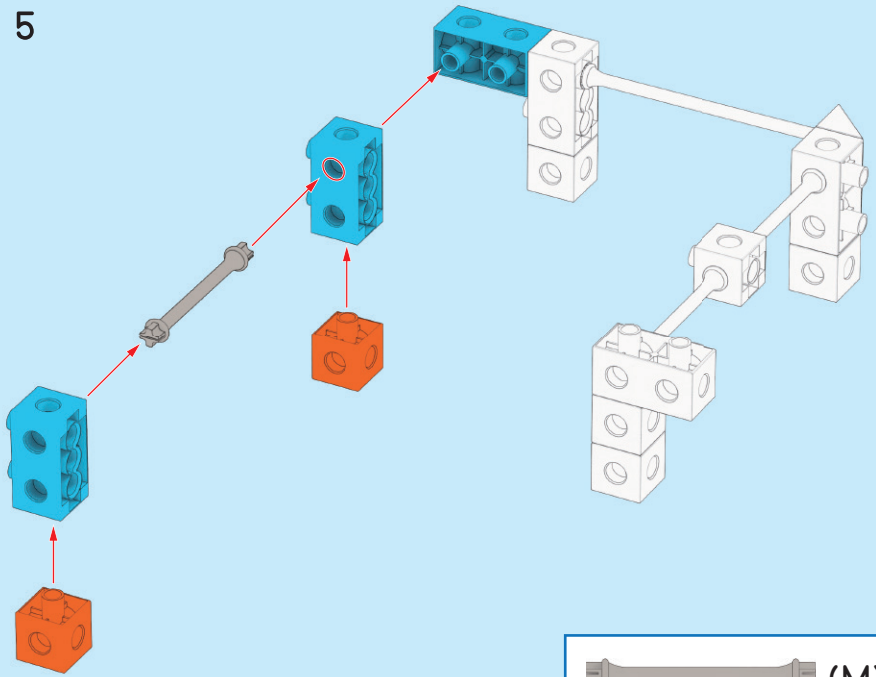

6

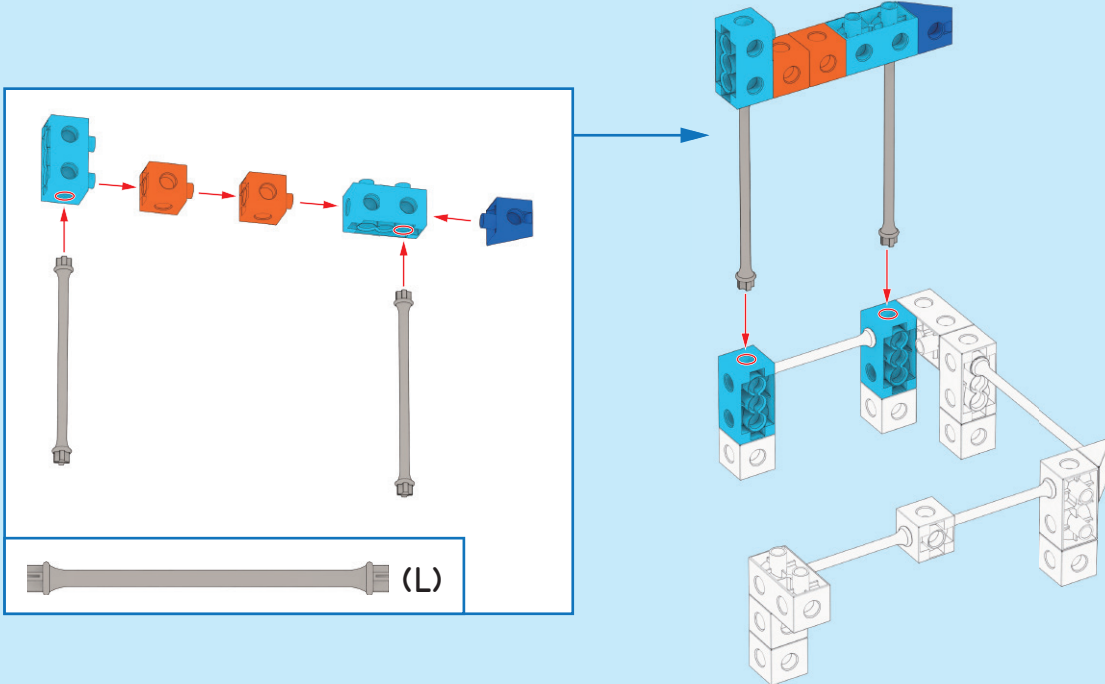

7

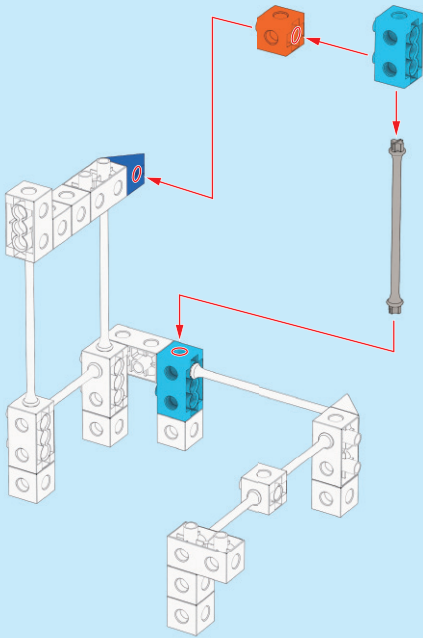

8

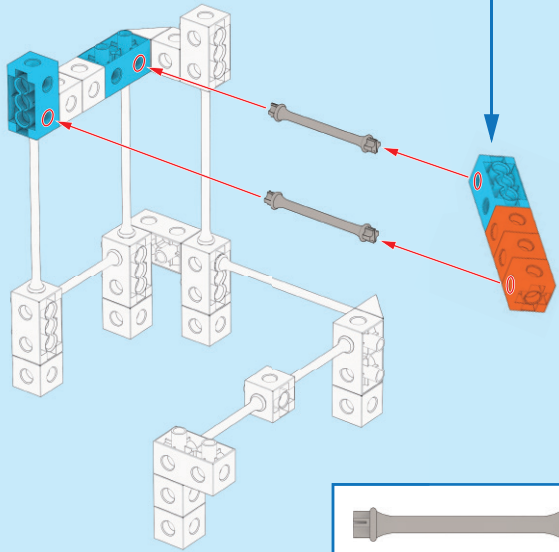
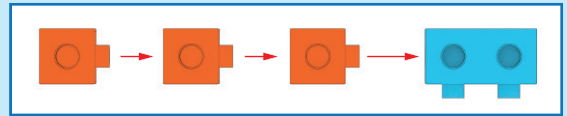

9

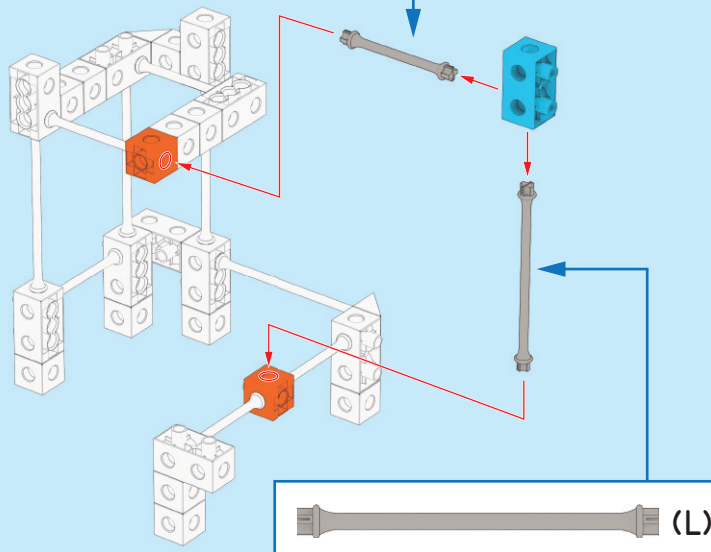

10

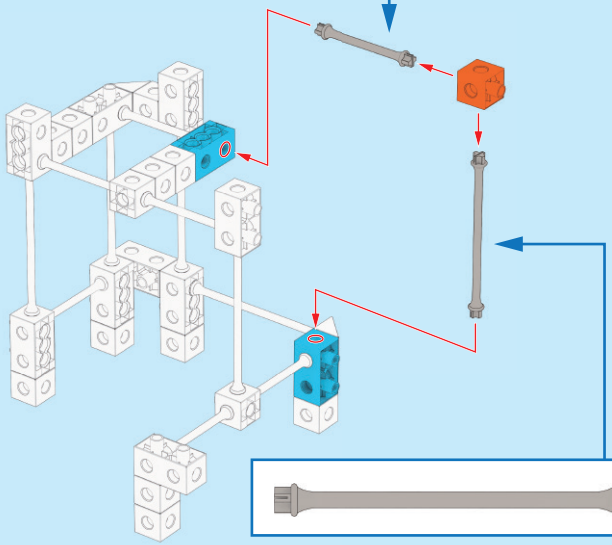

11

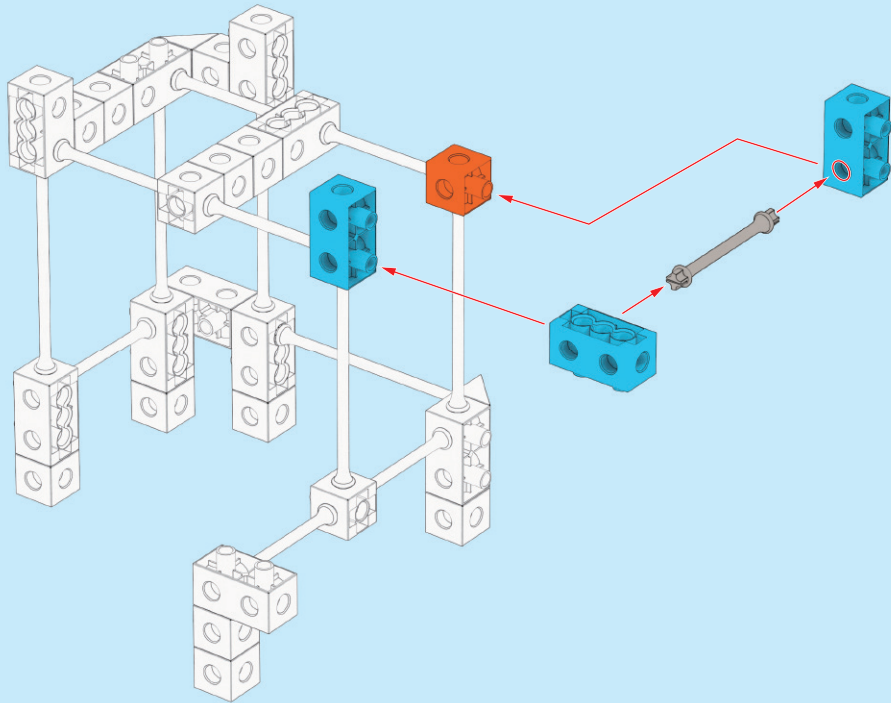

12

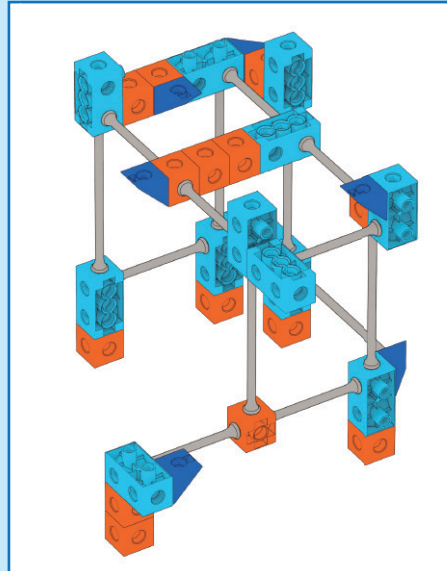
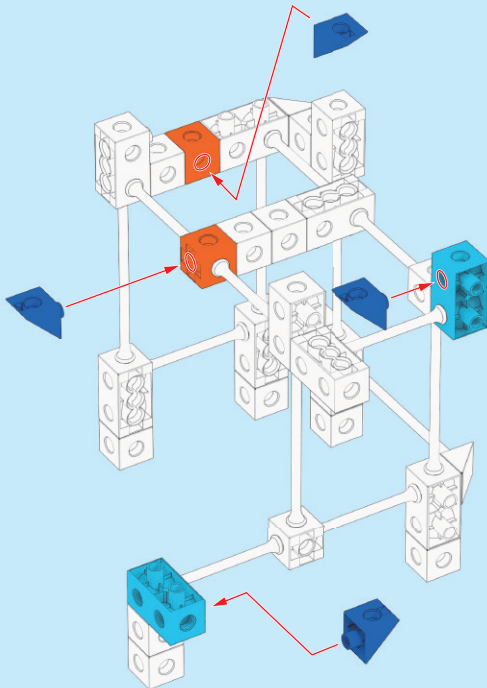

13

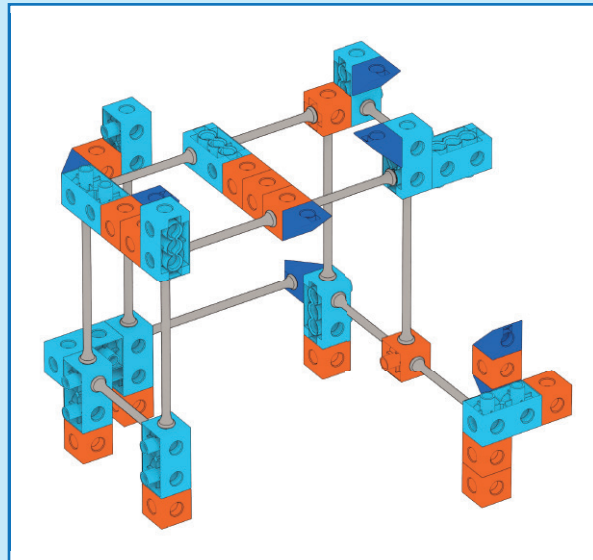
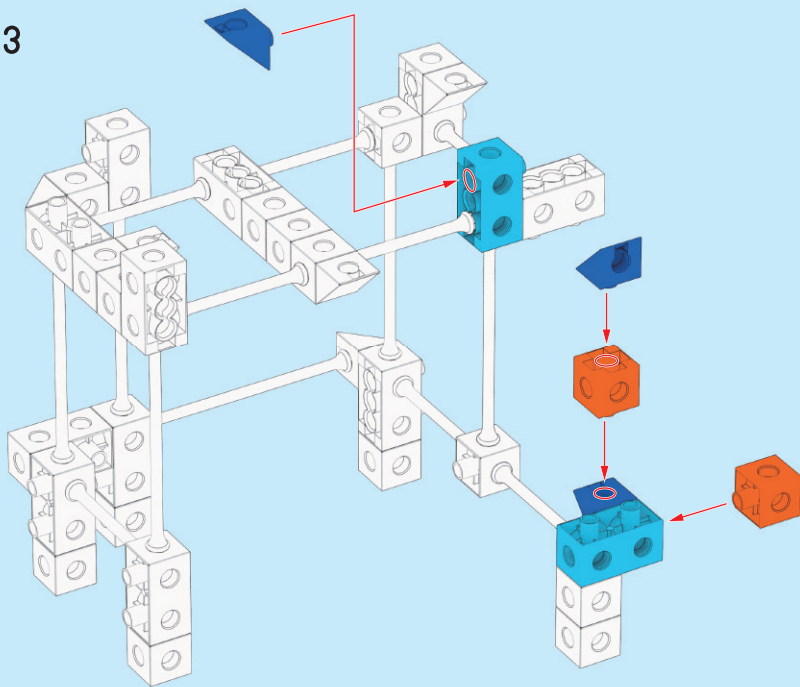

14

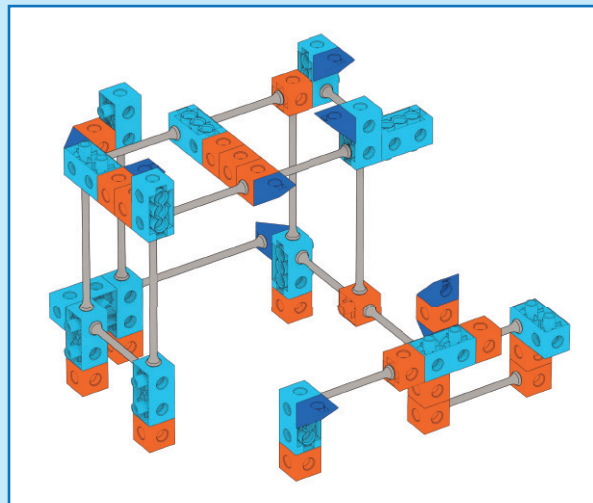
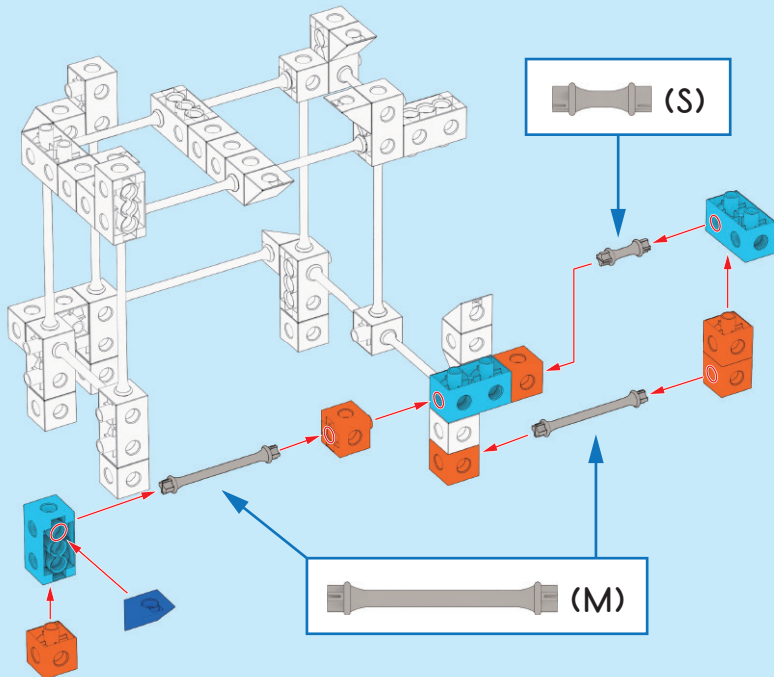

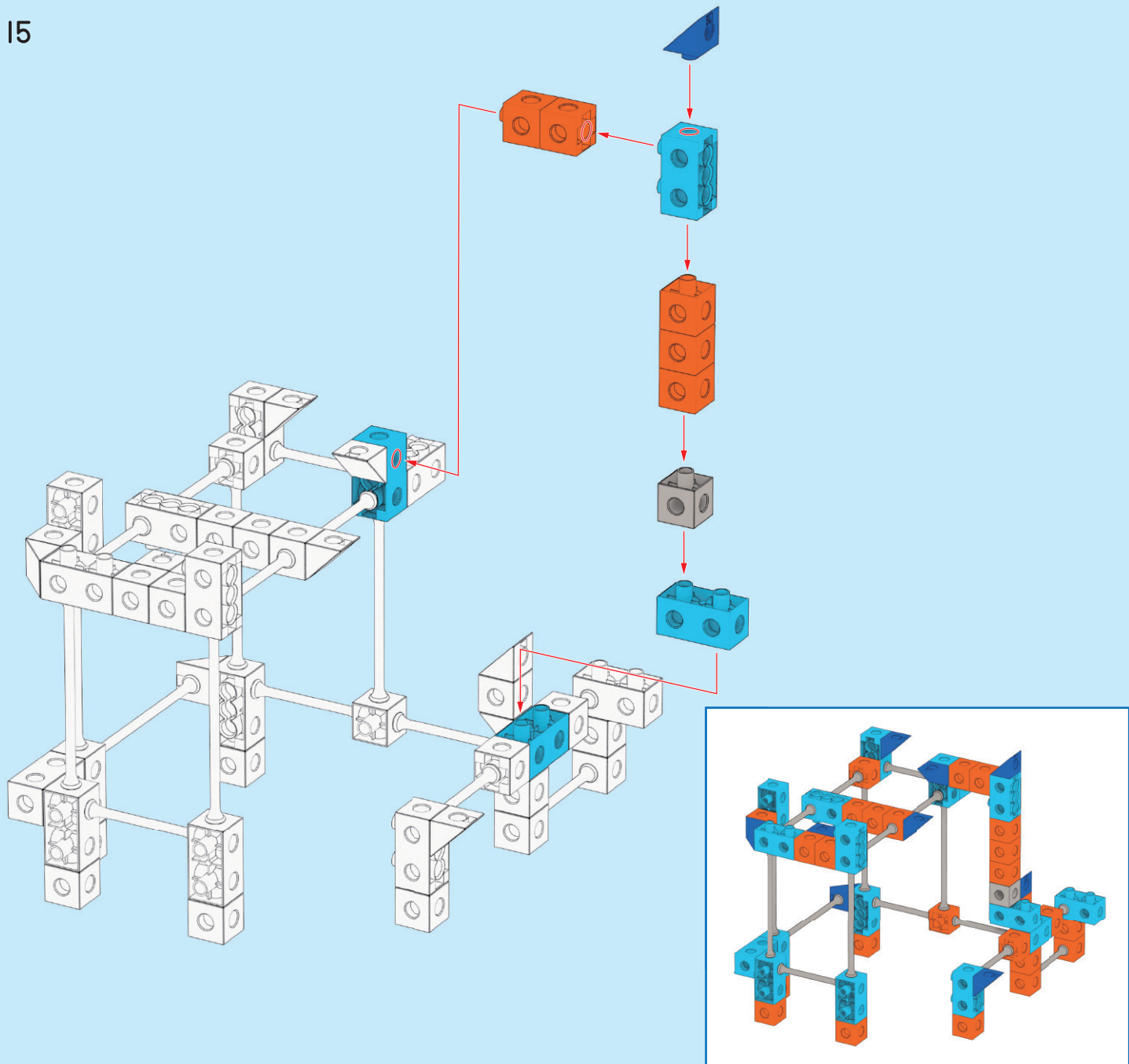

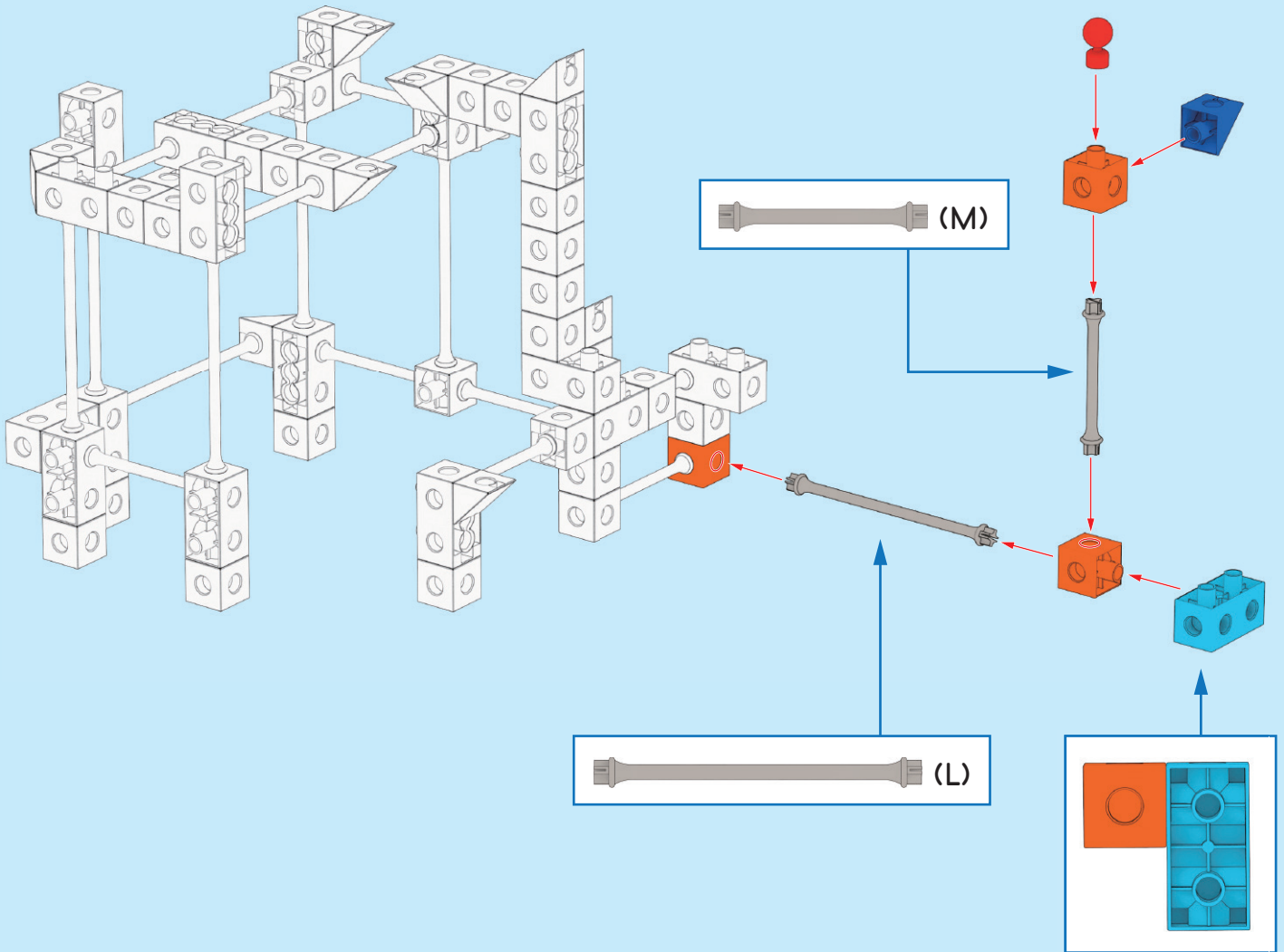

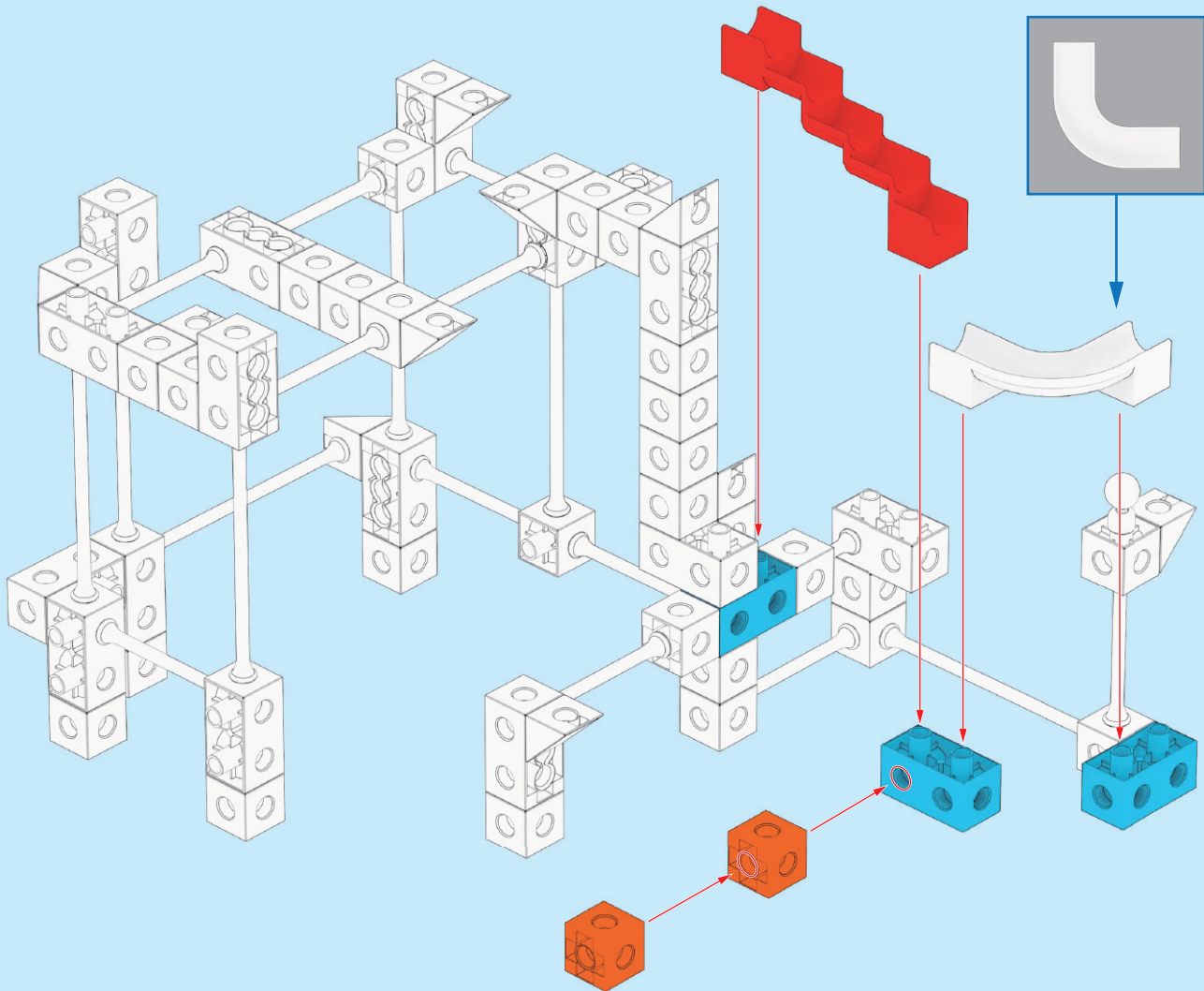

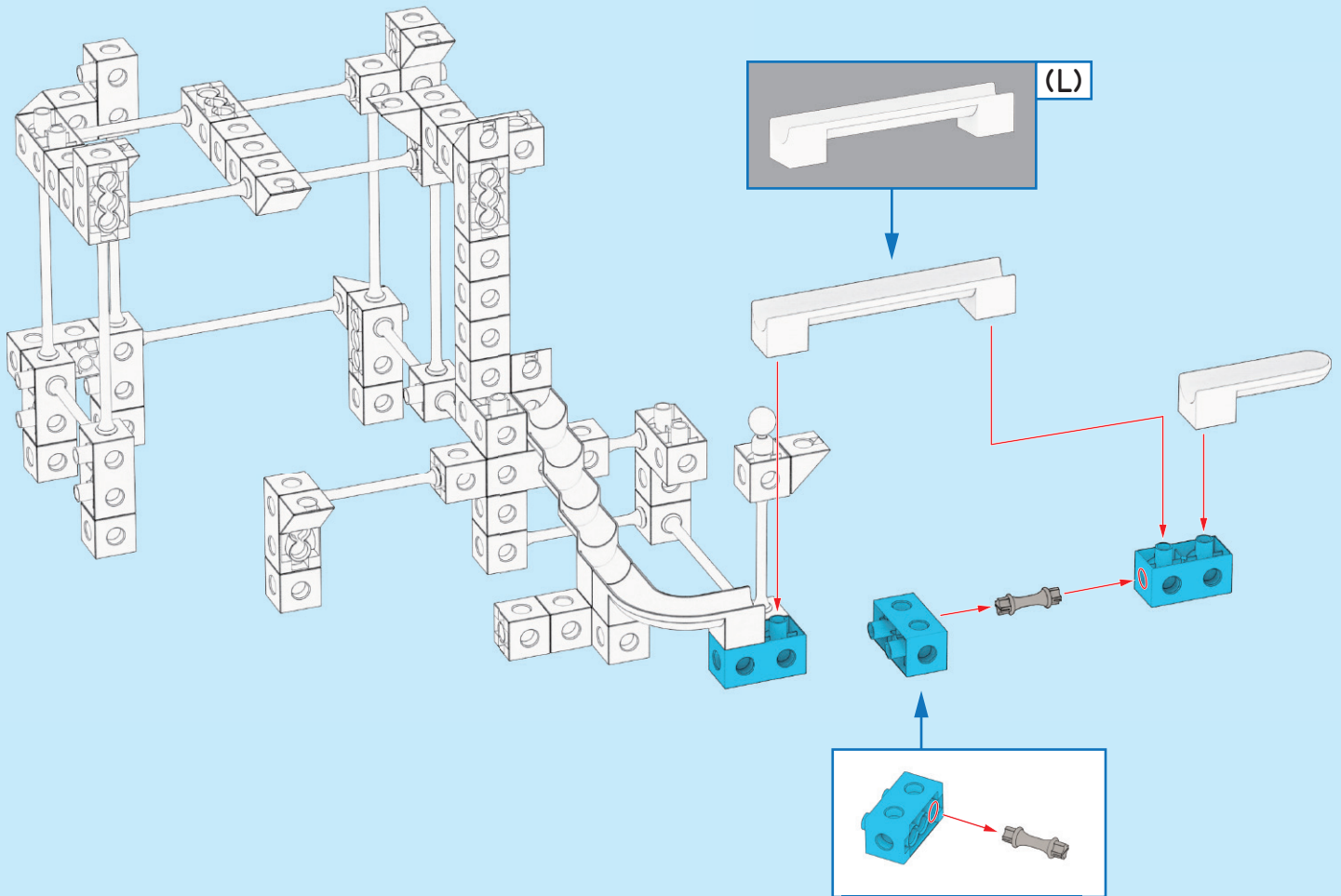

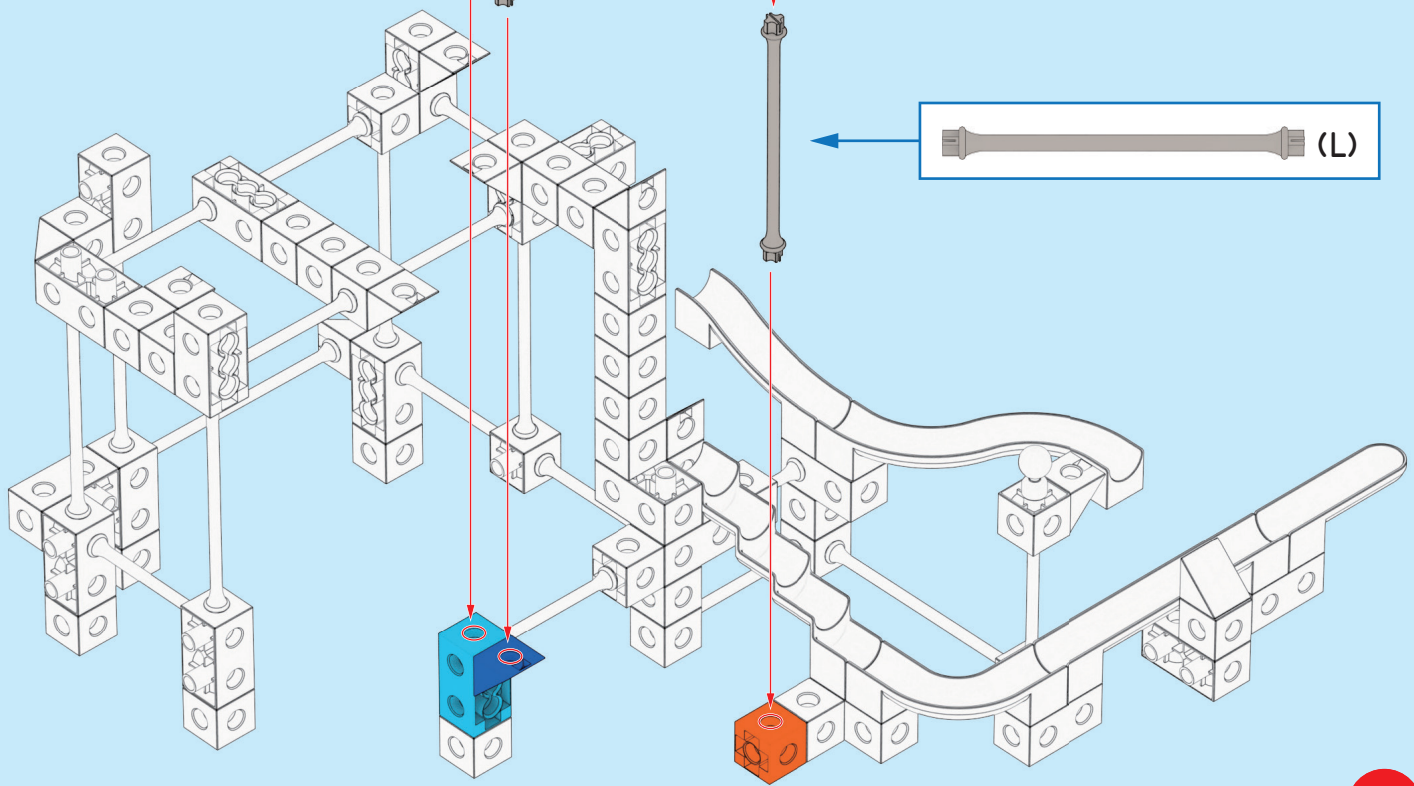
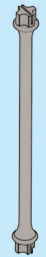
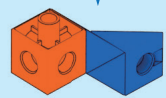
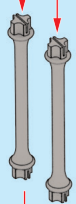
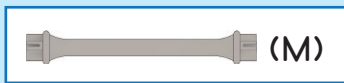
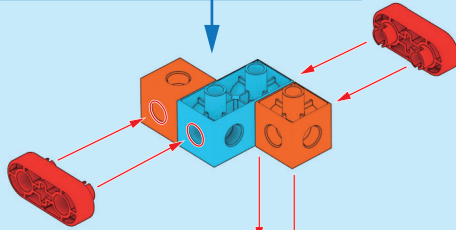
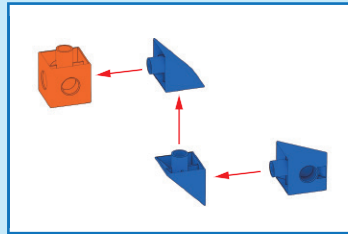
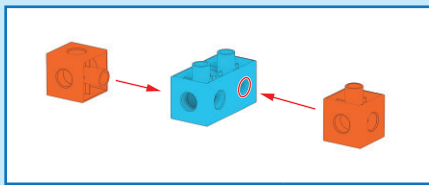

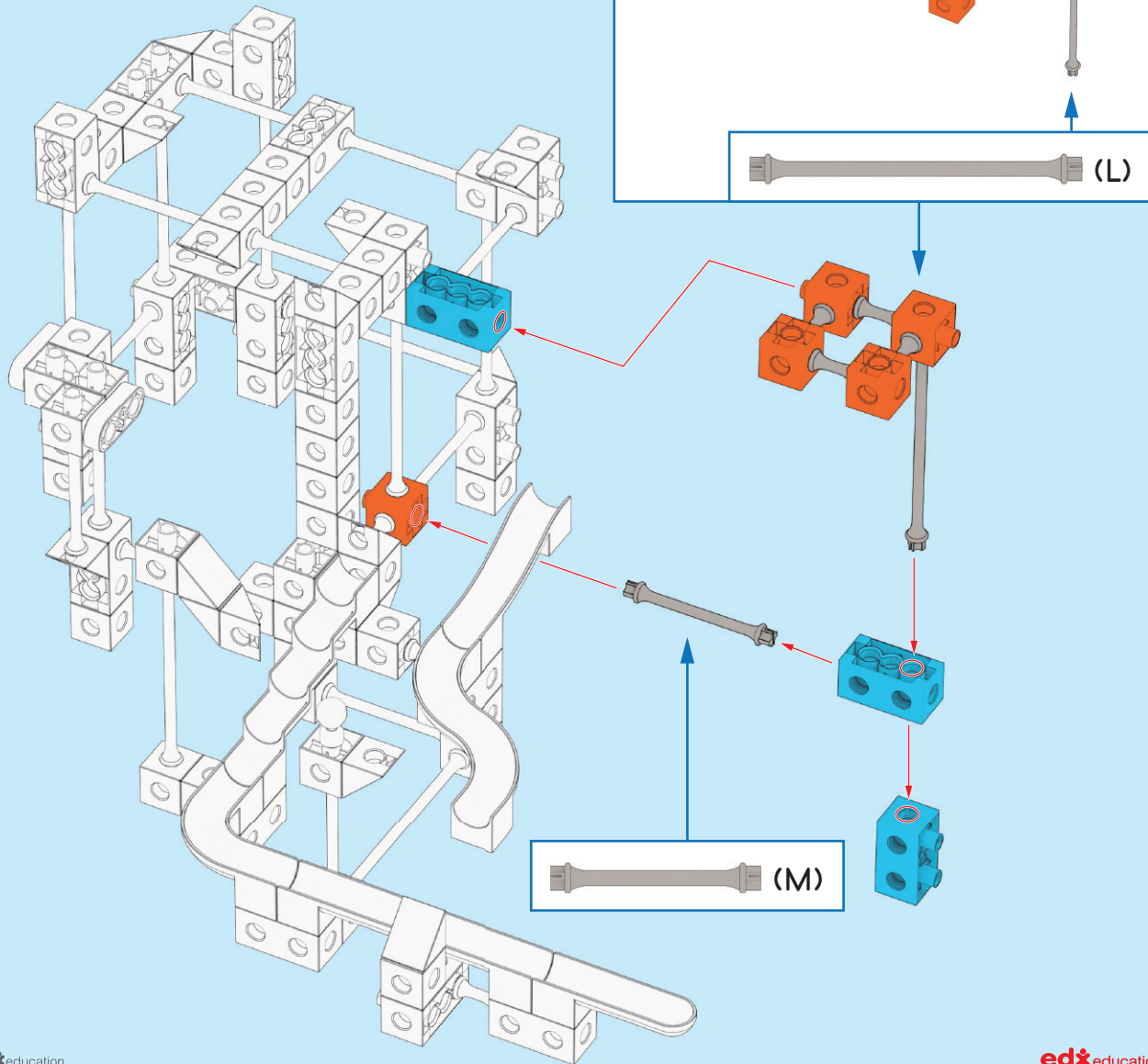

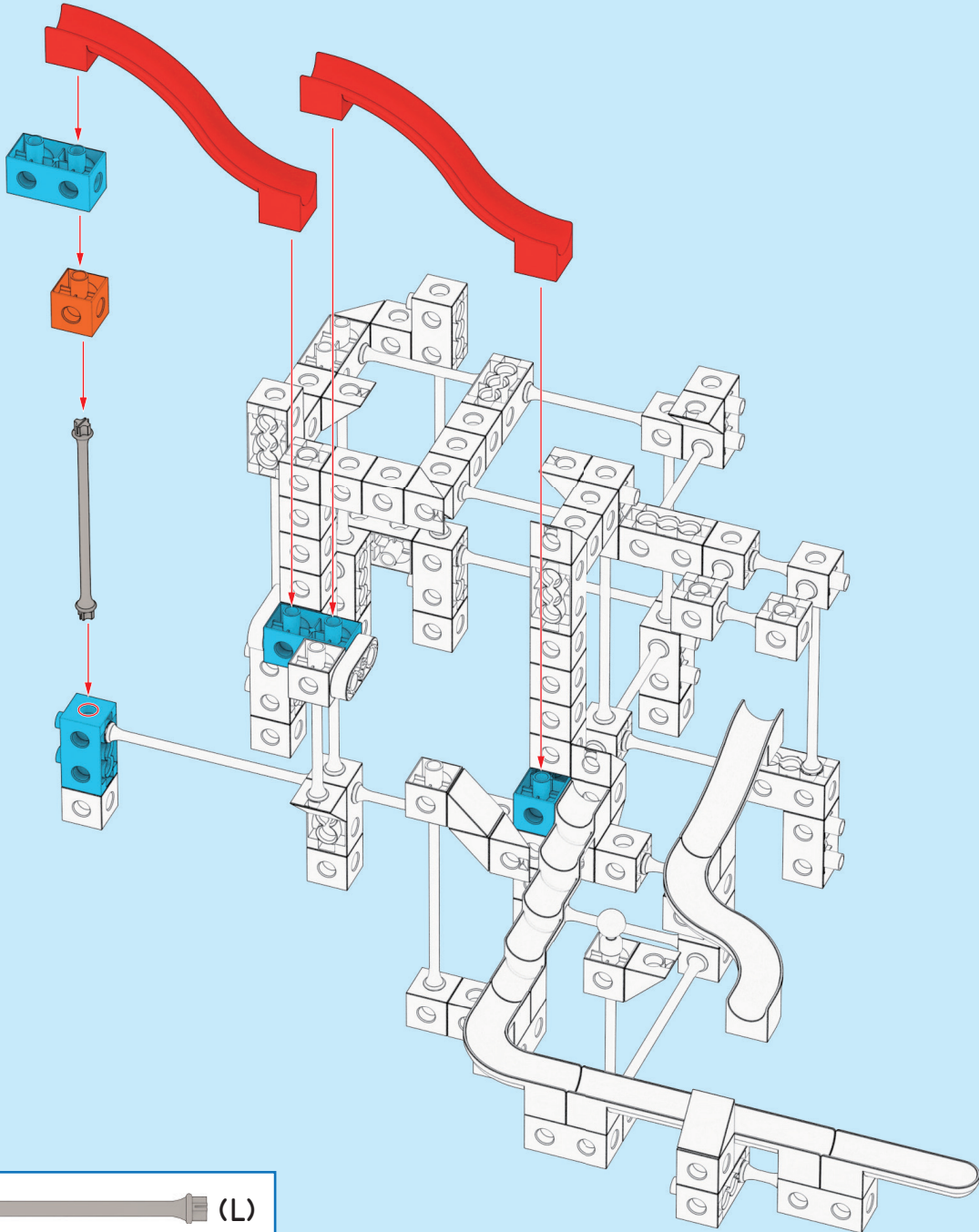

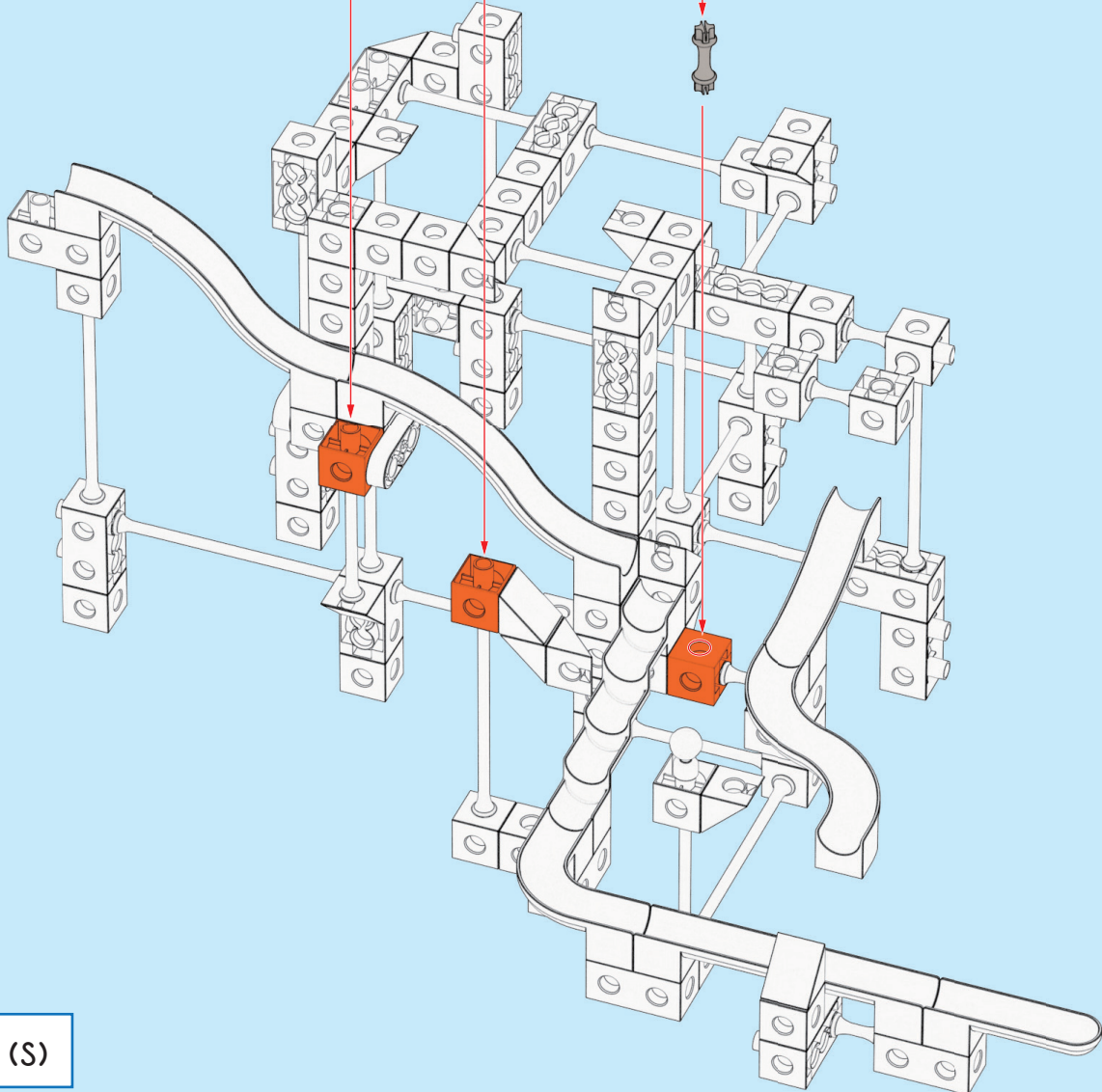
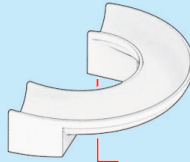
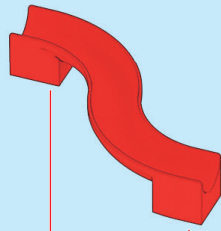
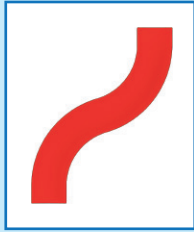

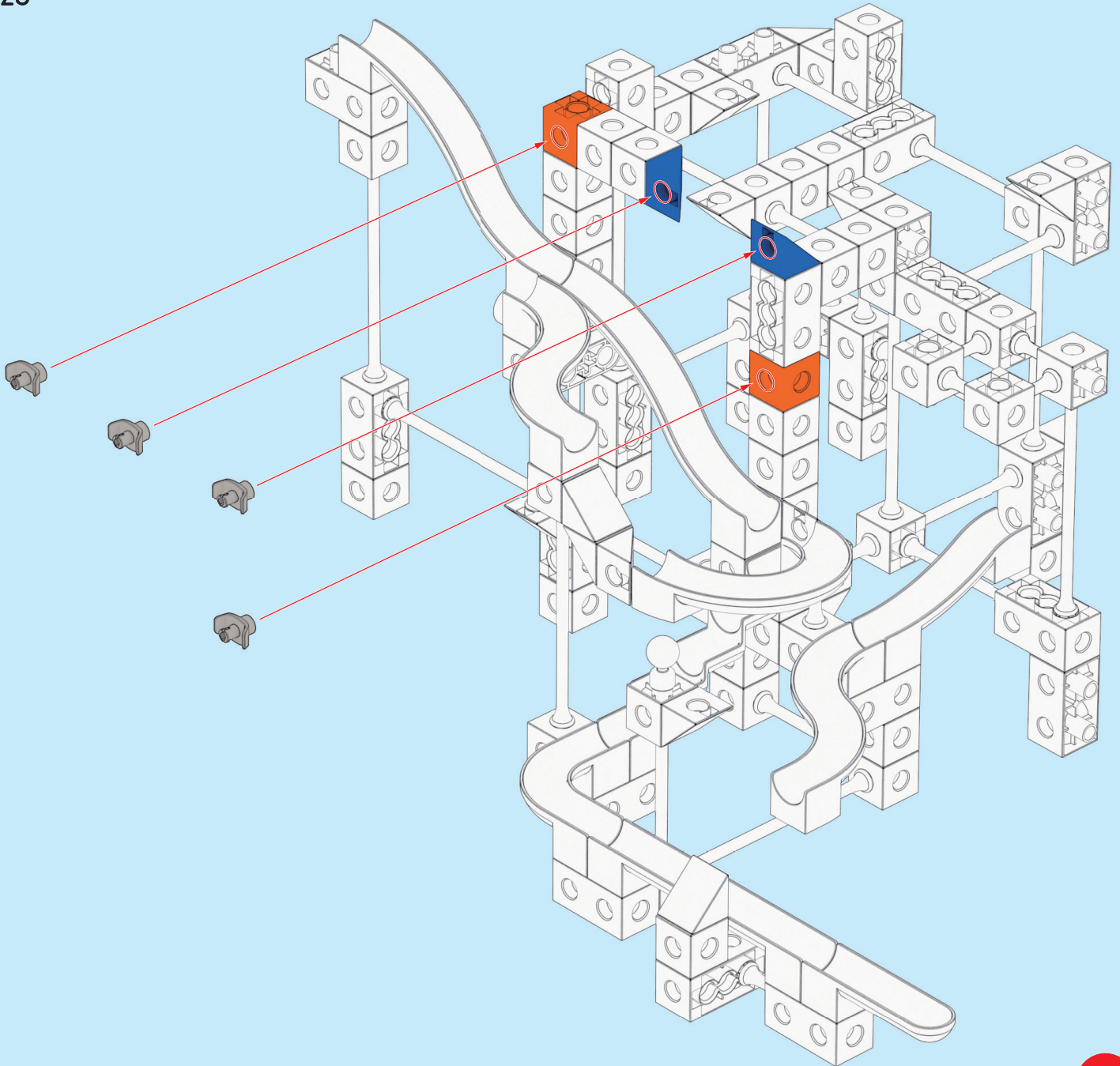

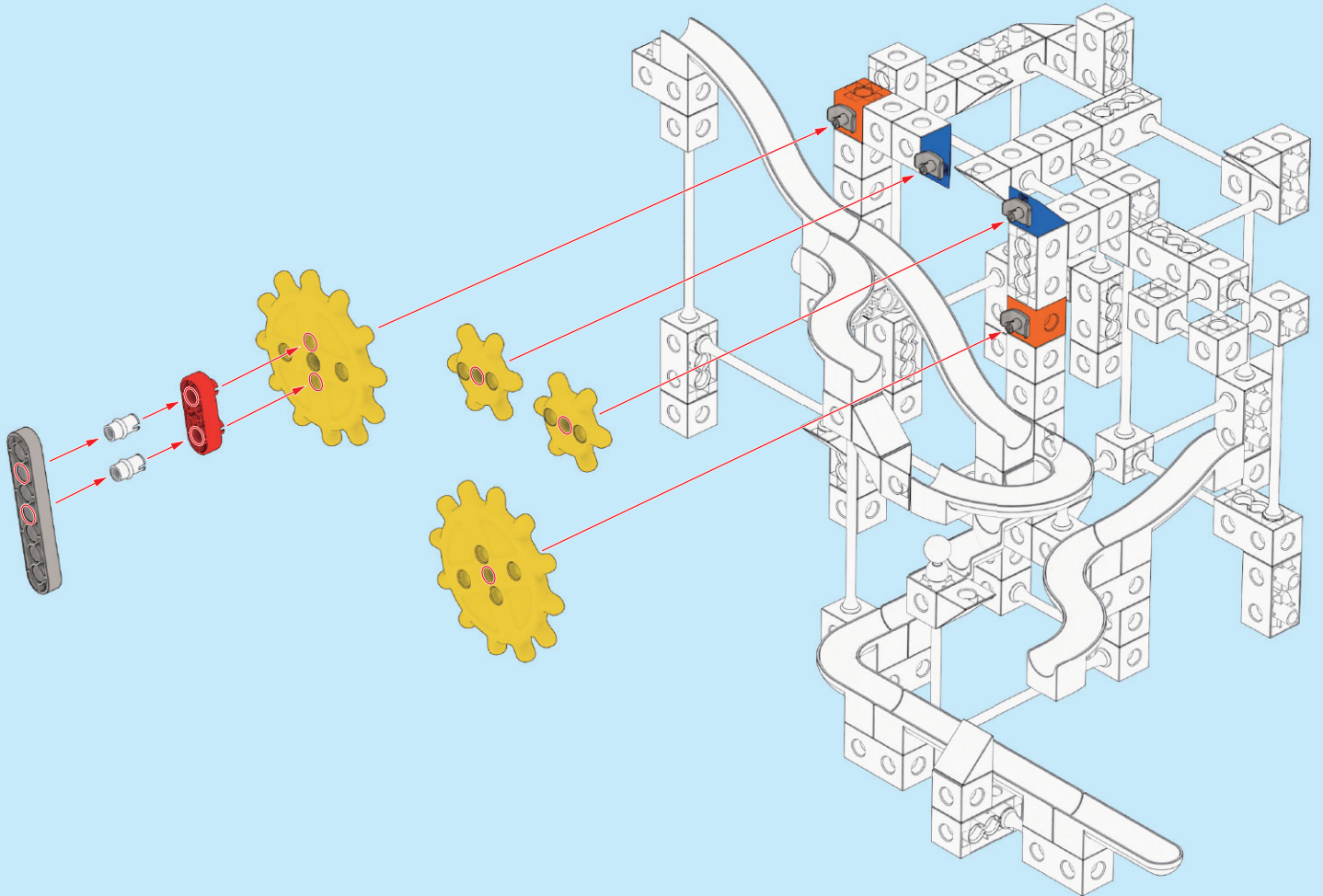

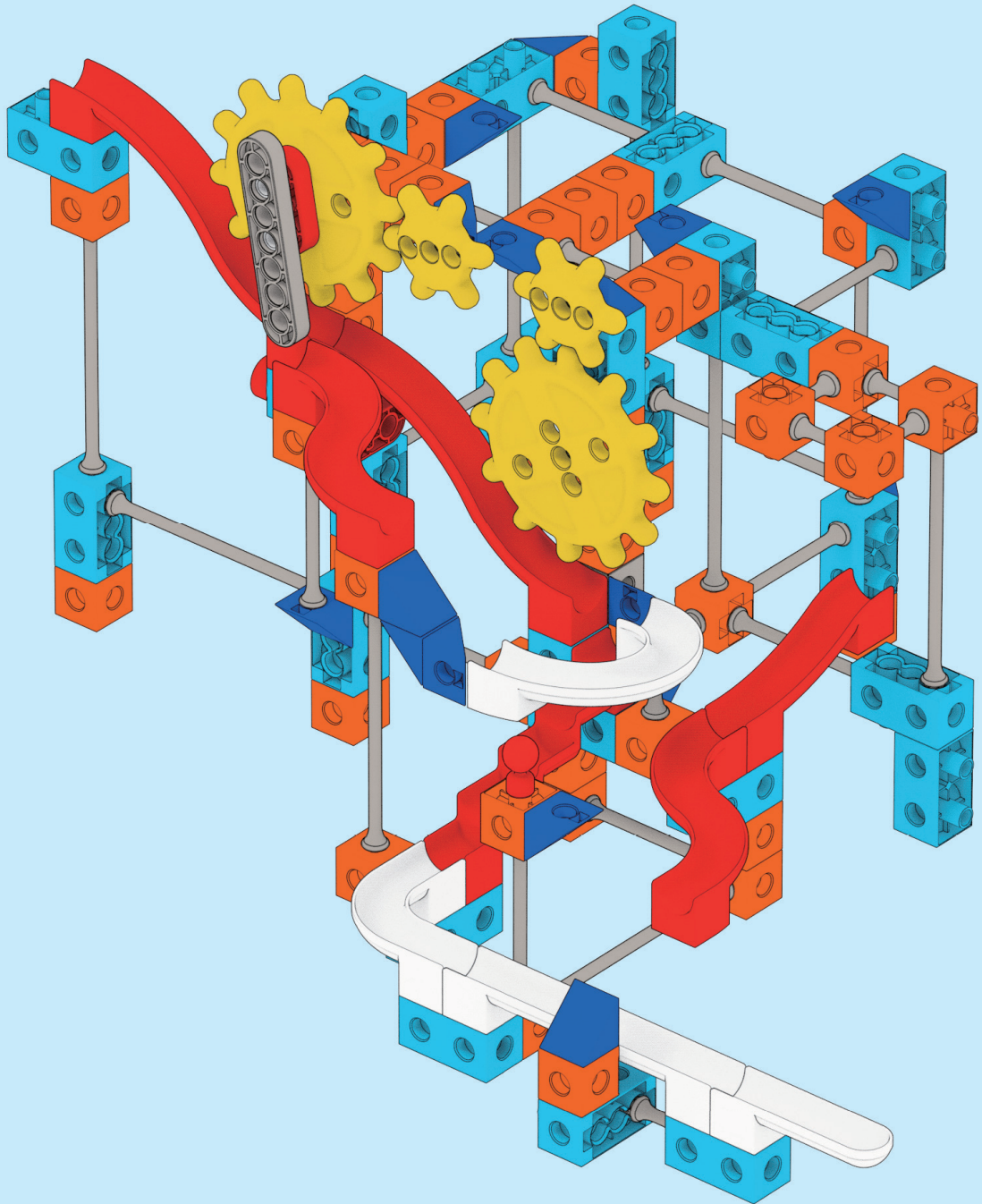

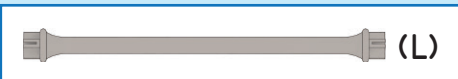
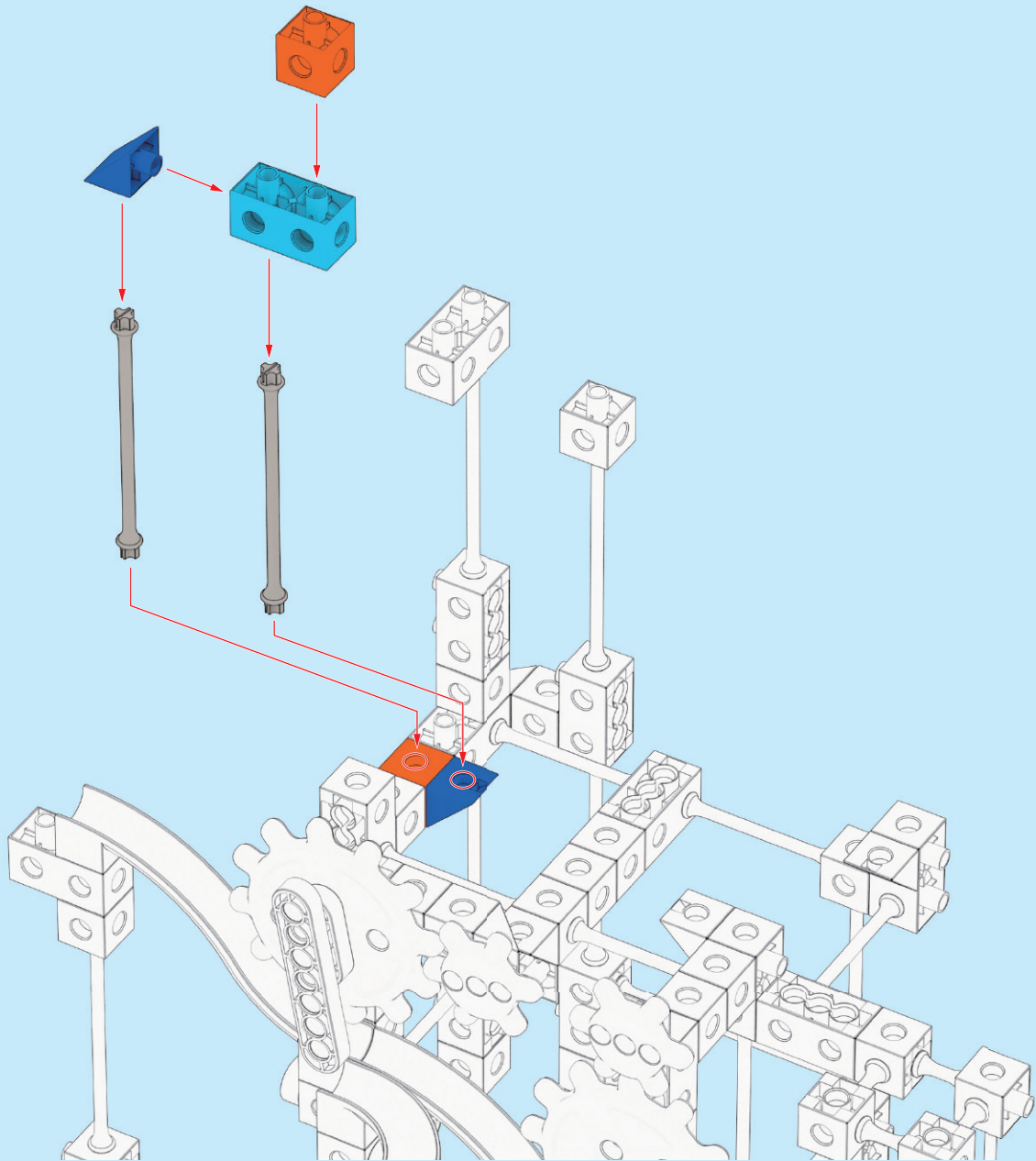

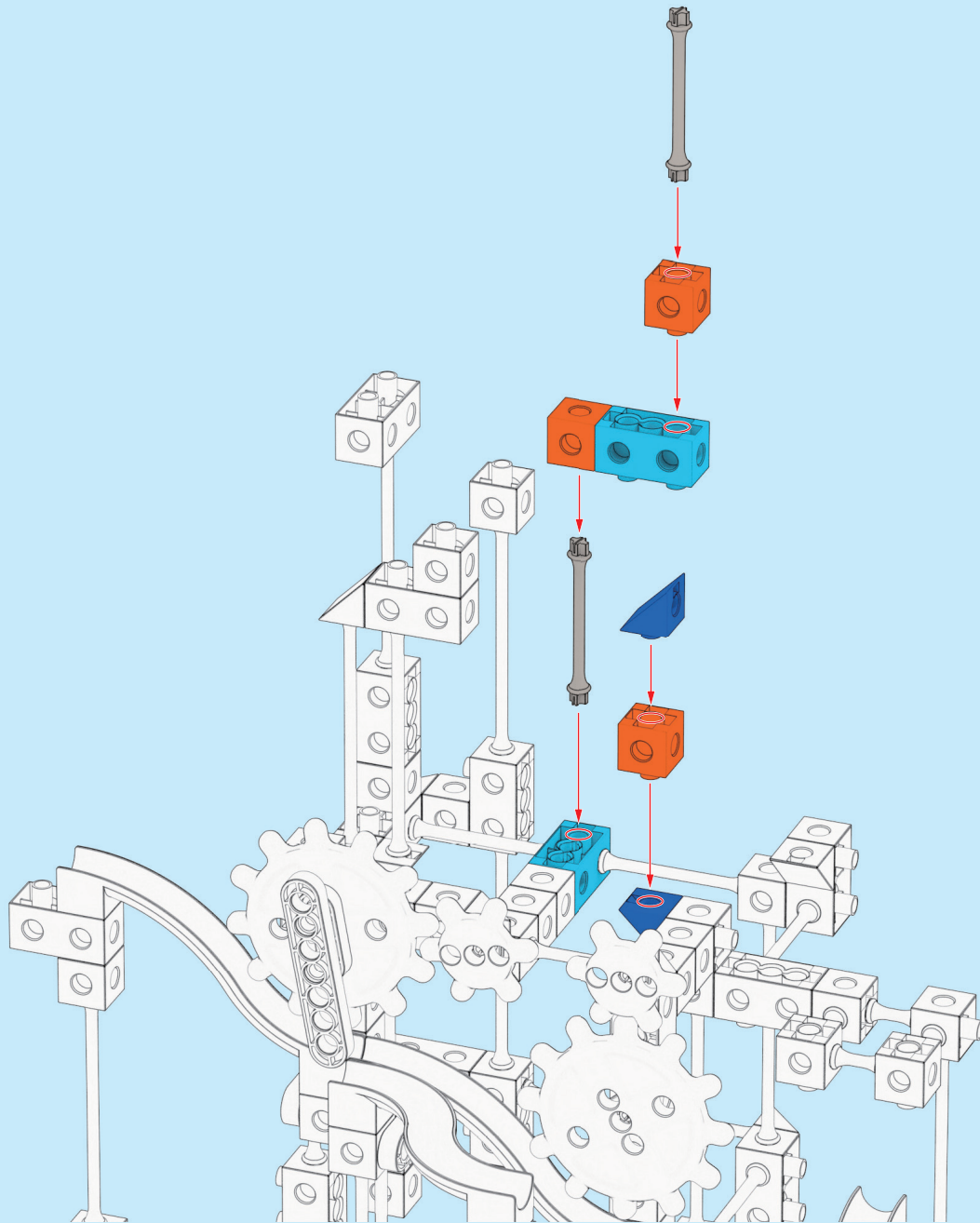

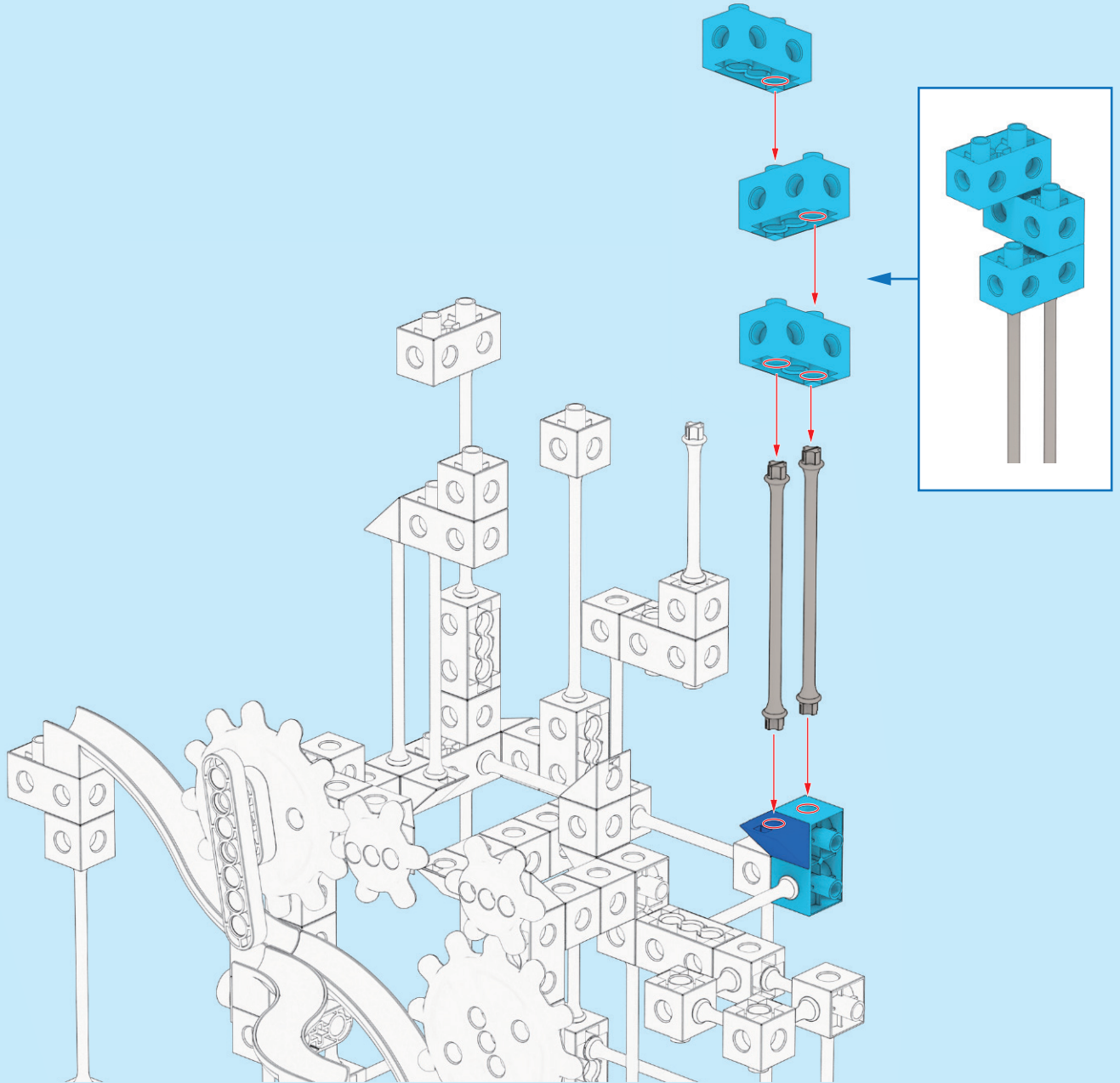

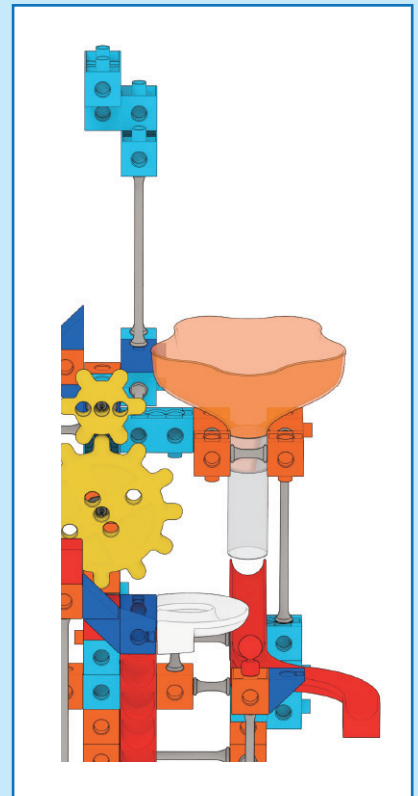
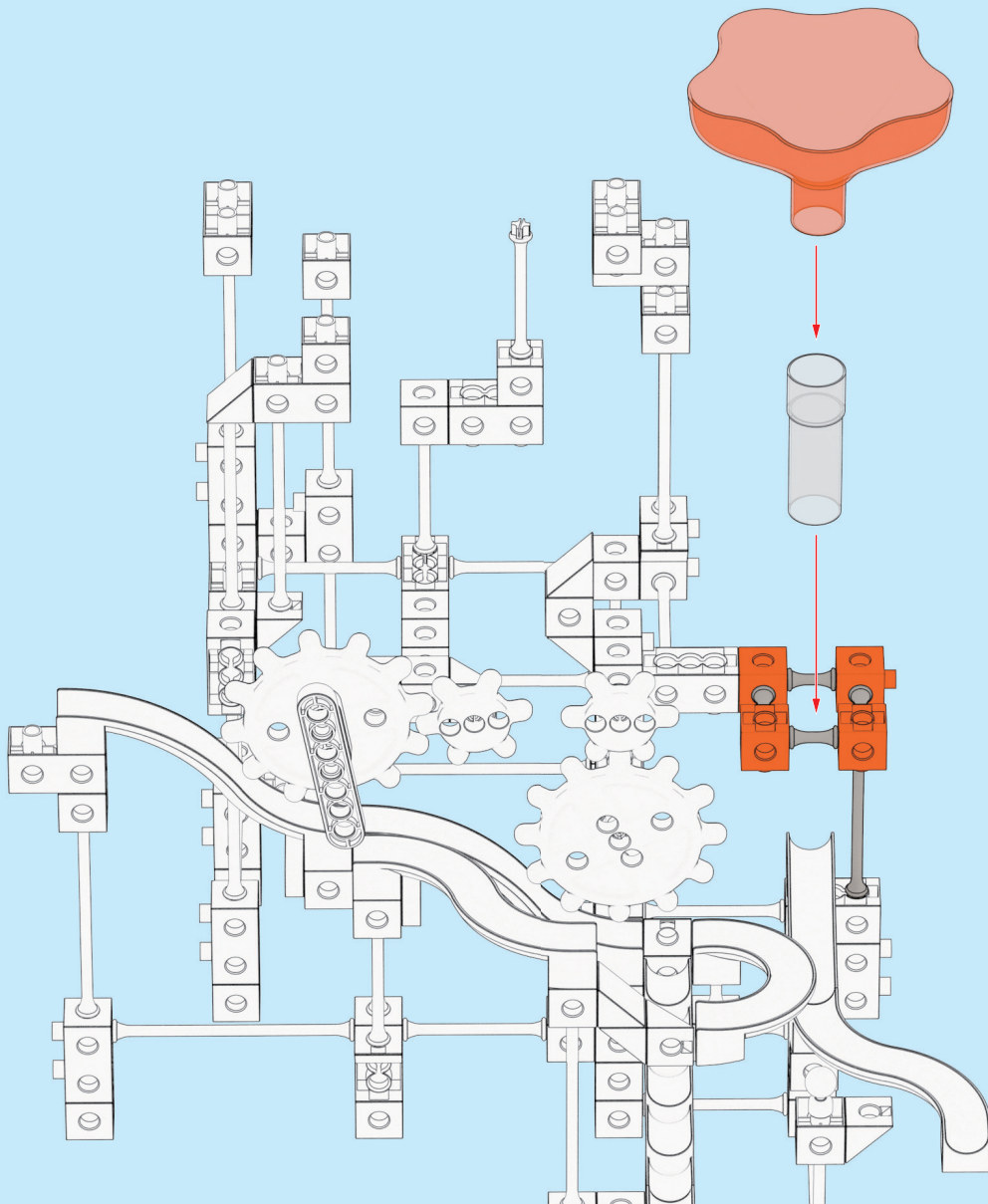

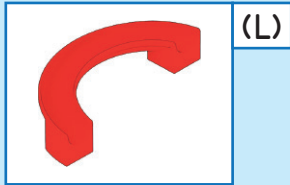
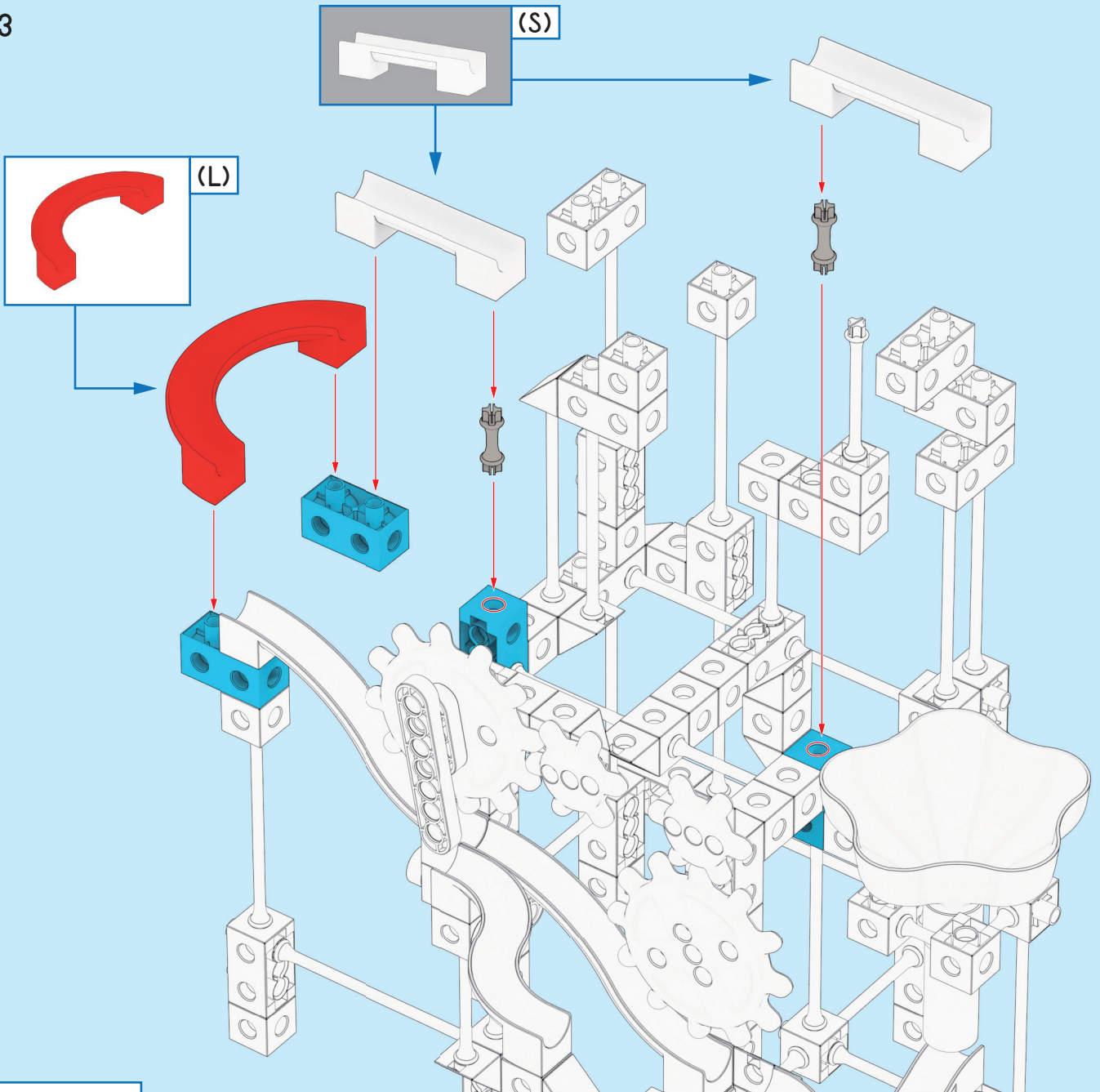

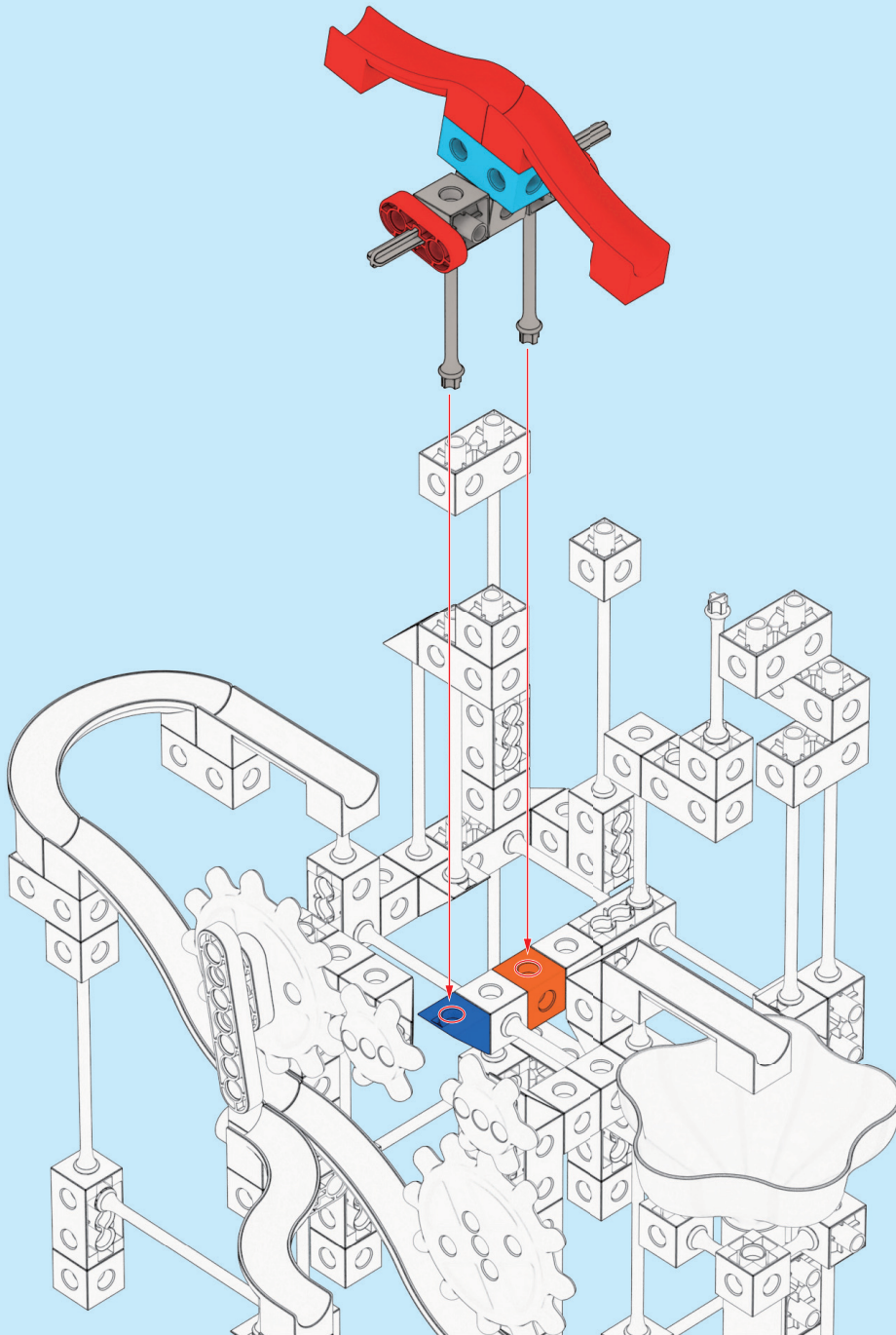

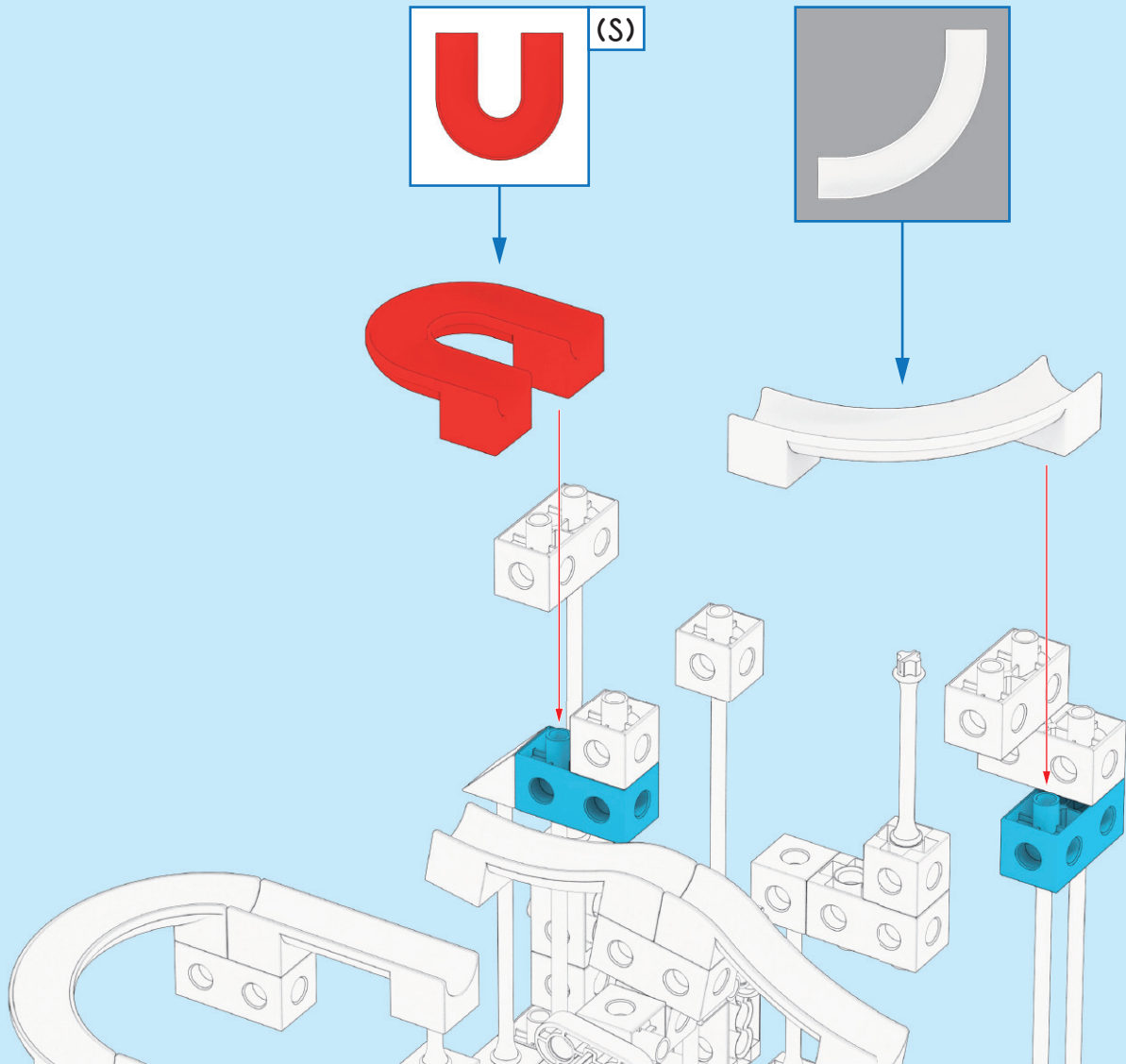

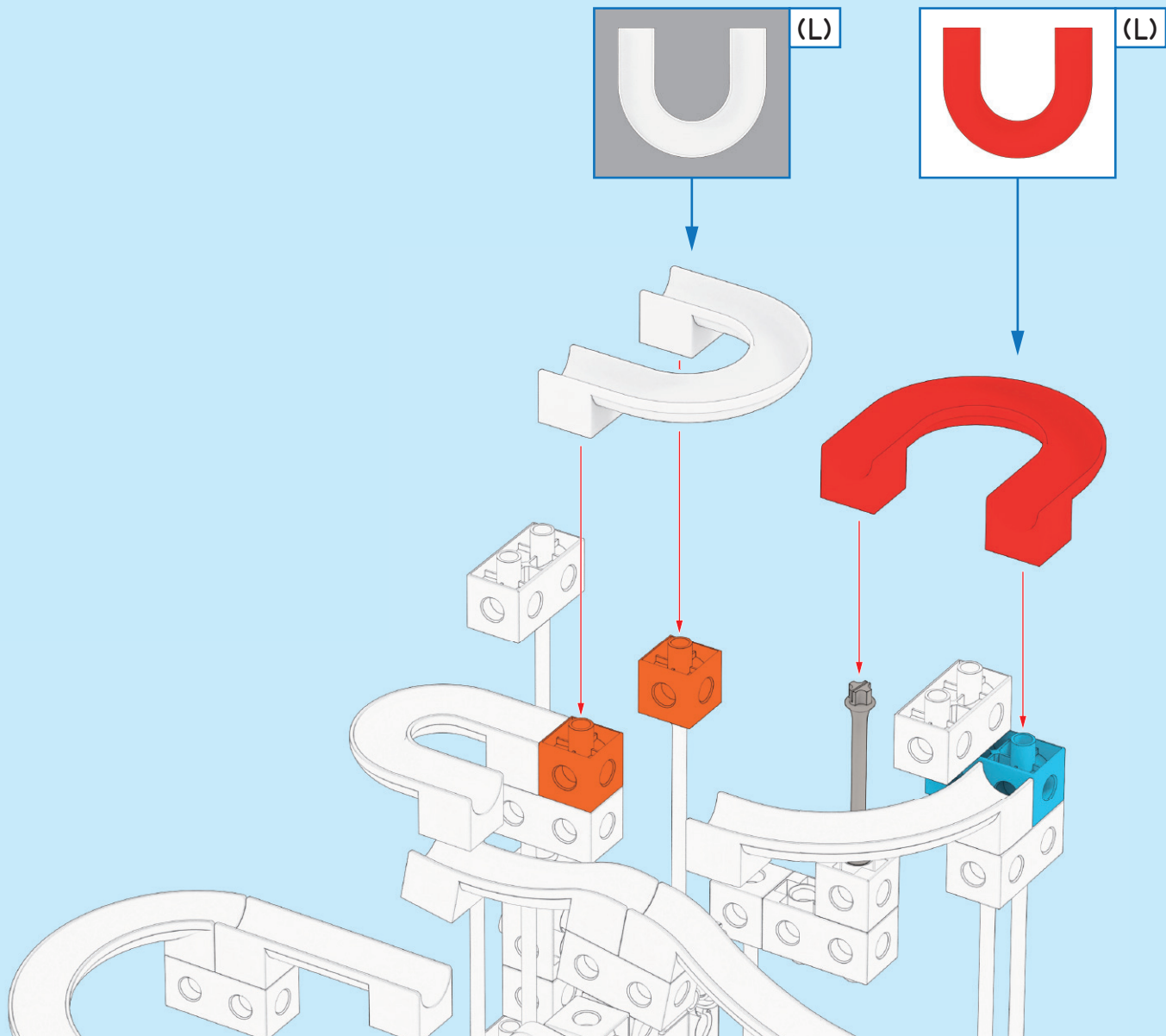

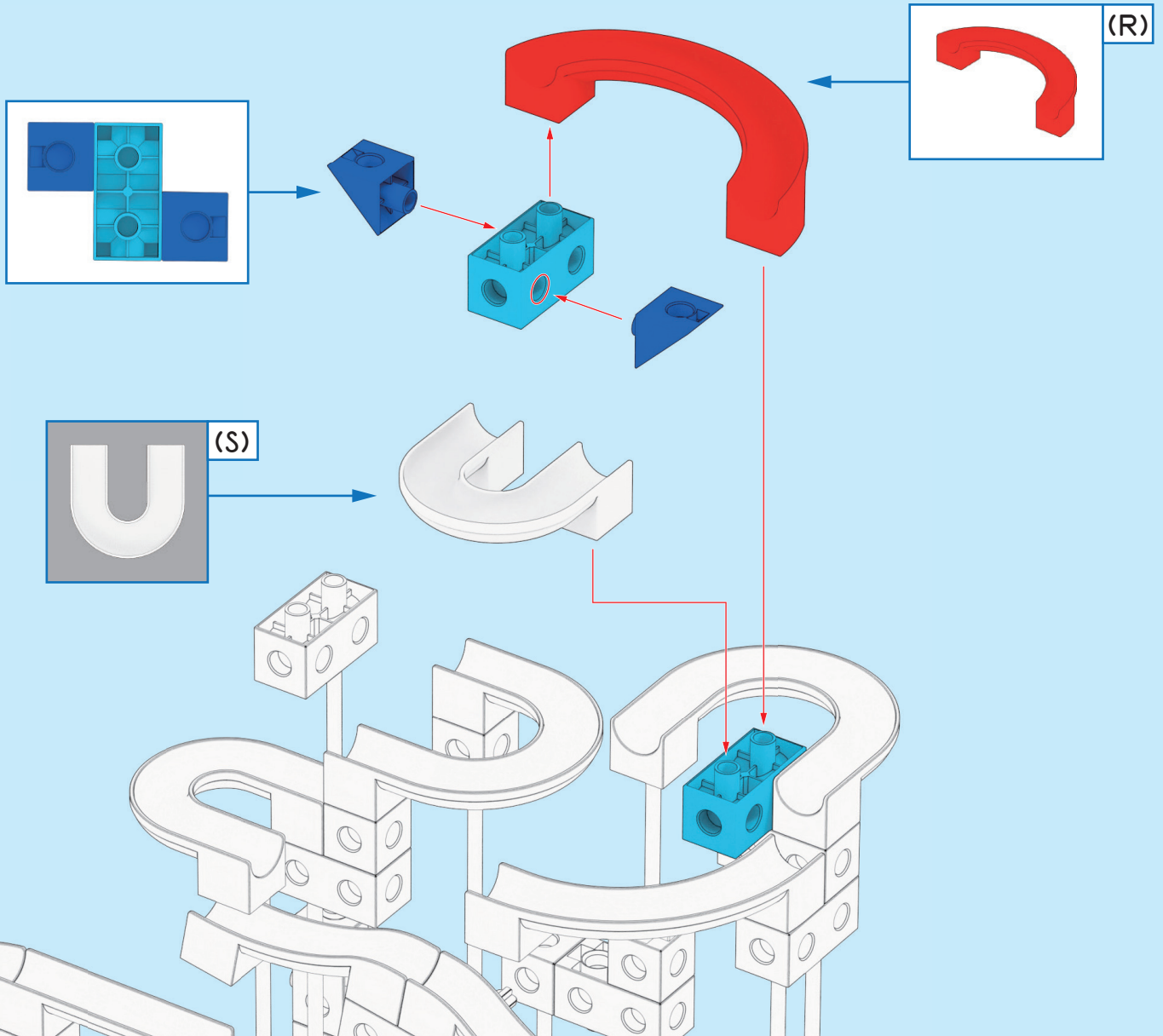

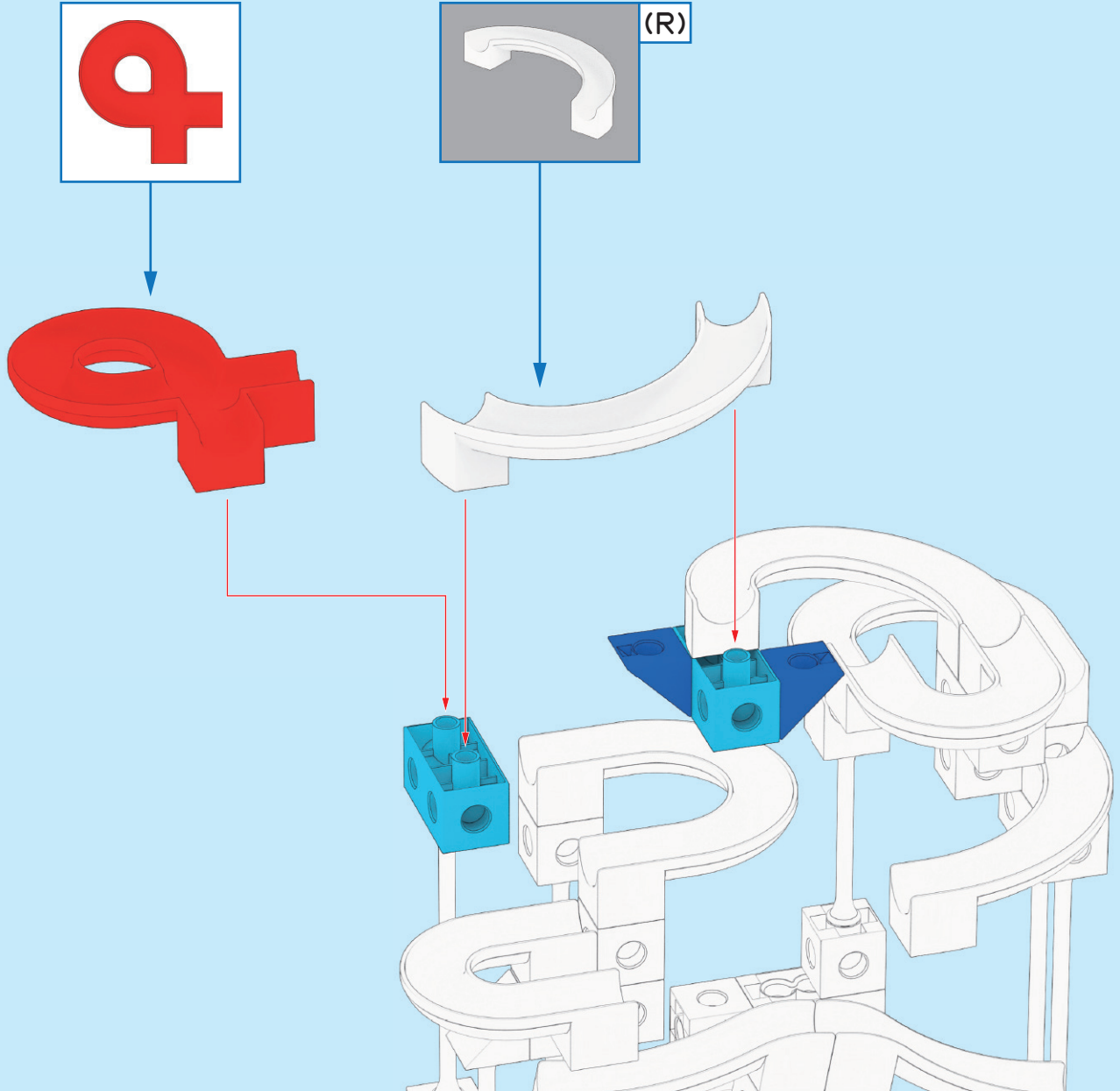

41

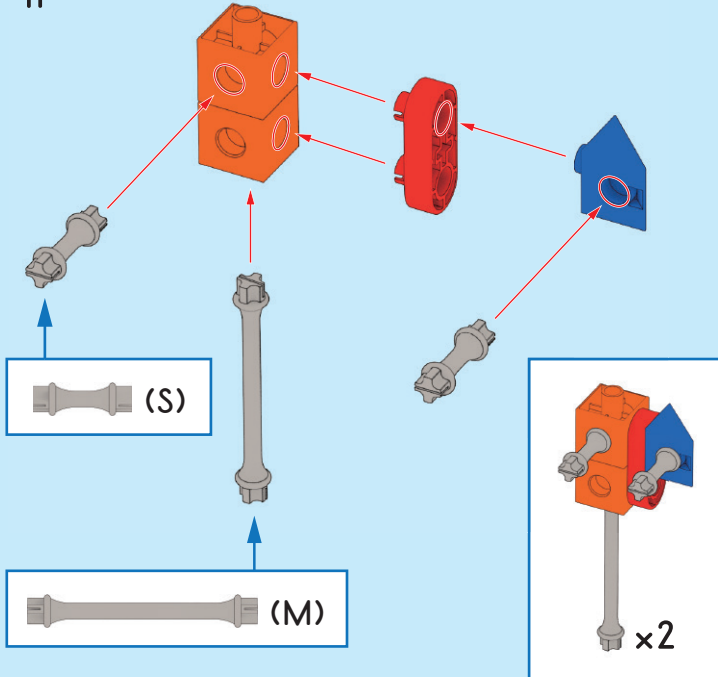

42

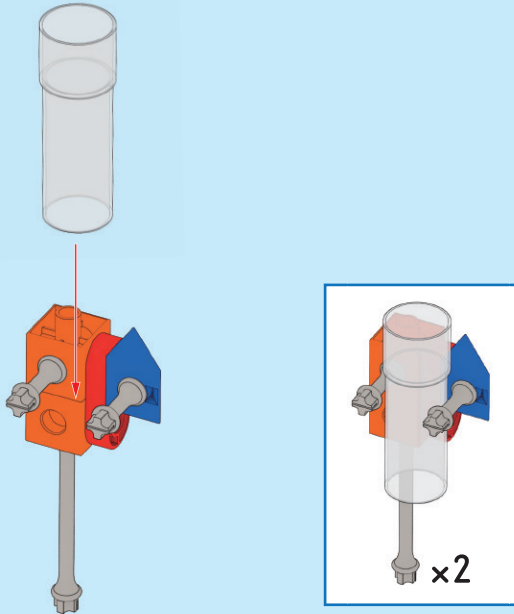

43

