

**roba**

roba Baumann GmbH

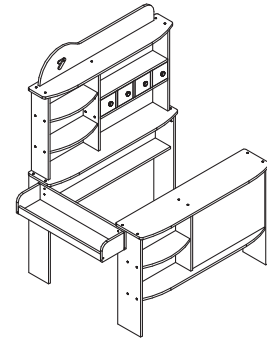
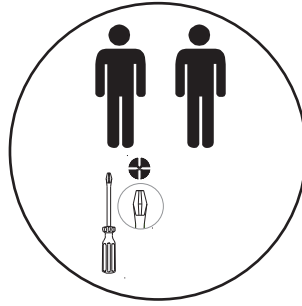

Feldstraße 14  
96237 Ebersdorf  
0 95 62. 92 21-20  
info@roba-kids.com  
www.roba-kids.com

## 9892 Verkaufsstand . Shop

**Aufbauanleitung . Assembly Instructions . Instruction d'assemblage . Instrucciones de montaje . Instruções de montagem . Istruzioni di montaggio . Opbouwhandleiding . Byggevejledning . Monteringsanvisning . Asennusohjeet . Monteringsinstruksjoner . Instrukcja montażu . Návod k sestavení . Szerelési útmutató . Skupština Upute . Instrucțiuni de asamblare . Uputstvo za sastavljanje . Montážny návod . Navodila za montažo . Montaj talimatı . Οδηγίες Συναρμολόγησης . Руководство по сборке**

- DE** WICHTIG! - FÜR SPÄTERE VERWENDUNG AUFBEWAHREN - SORGFÄLTIG LESEN!  
**UK** ATTENTION! - PLEASE STORE FOR FURTHER ENQUIRIES! READ CAREFULLY!  
**FR** IMPORTANT! - CONSERVER POUR UNE UTILISATION ULTÉRIEURE - LIRE ATTENTIVEMENT!  
**ES** ¡ATENCIÓN! - GUARDAR PARA UN USO POSTERIOR. - LÉASE DETENIDAMENTE!  
**PT** IMPORTANTE! - GUARDAR PARA FUTURAS CONSULTAS - LER COM ATENÇÃO!  
**IT** IMPORTANTE! CONSERVARE PER L'USO FUTURO - LEGGERE CON ATTENZIONE!  
**NL** BELANGRIJK! - BEWAAR DE HANDLEIDING VOOR LATERE RAADPLEGING! ZORGVULDIG LEZEN!  
**DK** VIGTIG! BØR OPBEVARES TIL SENERE BRUG - SKAL LÆSES GRUNDIGT!  
**SE** VIKTIG! SPARAS FÖR FRAMTIDA BRUK - MÅSTE LÄSAS NOGA!  
**FI** TÄRKEÄÄ! - SÄILYÄ MYÖHEMPÄÄ KÄYTTÖÄ VARTEN - LUE TARKKAVAISESTI!  
**NO** VIKTIG! - OPPBEVARES FOR SENERE BRUK - MÅ LESES NØYE!  
**PL** WAŻNE! ZACHOWAĆ NA PRZYSZŁOŚĆ! STARANNIE PRZECZYTAĆ!  
**CZ** DŮLEŽITÉ! - NÁVOD SI USCHÓVEJTE PRO POZDĚJŠÍ POUŽITÍ! - PEČLIVĚ SI JEJ PROČTĚTE!  
**HU** FONTOS! - KÉSŐBBI FELHASZNÁLÁSRA ÓRIZZE MEG - GONDOSAN OLVASSA EL!  
**HR** VAŽNO! - SAČUVATI ZA KASNIJU UPORABU - PAŽLJIVO PROČITATI!  
**RO** IMPORTANT! - PĂSTRĂȚI PENTRU UTILIZARE ULTERIOARĂ - CITIȚI CU ATENȚIE!  
**RS** VAŽNO! - ČUVATI ZA KASNIJU UPOTREBU - PAŽLJIVO SVE PROČITATI!  
**SK** DÔLEŽITÉ! - NÁVOD UCHOVAJTE NA NESKORŠIE POUŽITIE - DÔKLADNE SI HO PREČÍTAJTE!  
**SI** POMEMBNO! - SHRANITE ZA KASNEJŠO UPORABO - TEMELJITO PREBERITE!  
**TR** ÖNEMLİ!-DAHA SONRA KULLANILMAK ÜZERE DE MUHAFZA EDİNİZ- DİKKATLE OKUYUNUZ!  
**GR** ΣΗΜΑΝΤΙΚΟ! - ΝΑ ΦΥΛΑΣΣΕΤΑΙ ΓΙΑ ΑΡΓΟΤΕΡΗ ΧΡΗΣΗ - ΝΑ ΔΙΑΒΑΖΕΤΑΙ ΜΕ ΠΡΟΣΟΧΗ!  
**RU** ВАЖНО: ВНИМАТЕЛЬНО ПРОЧИТАТЕ И СОХРАНИТЕ!



77500-01.14











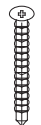

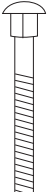

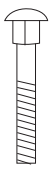

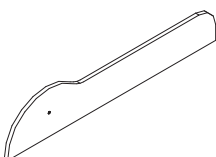
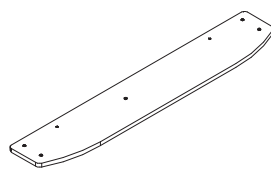



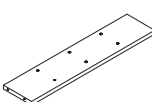
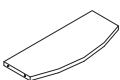
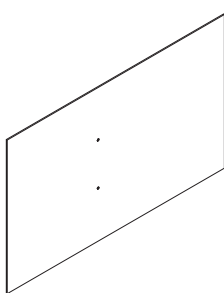
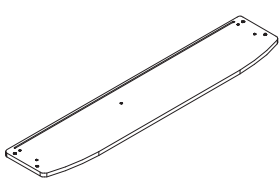





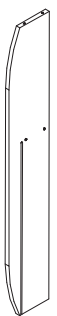

Service

@ info@roba-kids.com  
www.roba-kids.com

Bei Rückfragen zu diesem Artikel bitte die folgende **Kenn-Nummer** und **Art.-Nr.** angeben:  
If you have any questions concerning this article use this **identification number** and **item number**:

**9892 -**

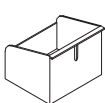
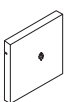

A	B	C	D	E	F								
58x	2x	4x	5x	1x	4x								
 4x35	 4x20	 M5x35	 M5x20x10	 M5x30	 4x25								
1	2		3	4	5	6	7	8					
1x	1x		1x	1x	1x	3x	2x	3x					
													
9	10		11	12	13	14	15	16	17				
1x	1x		1x	1x	1x	1x	1x	1x	1x				
													
18	19	20	21	22	23	24	25	26	27	28	29	30	
1x	1x	1x	1x	1x	1x	1x	1x	1x	1x	4x	4x	4x	
													

A	B	E	D
			
36x	2x	1x	1x

1

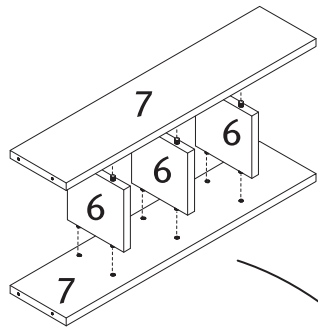

2

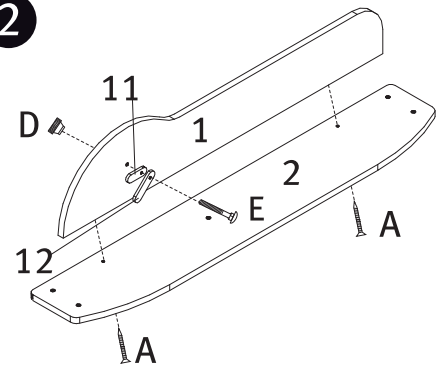

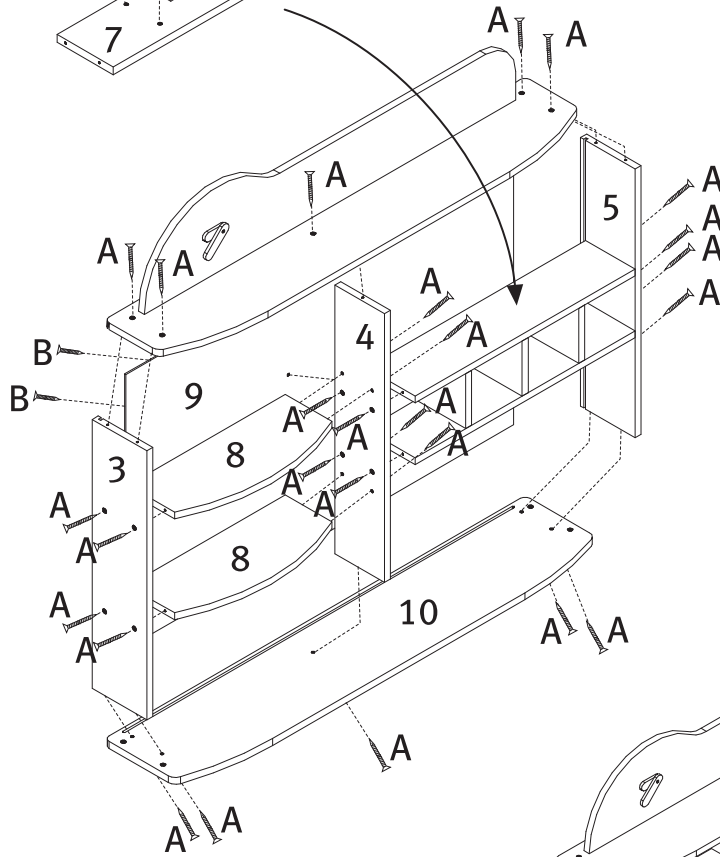

3

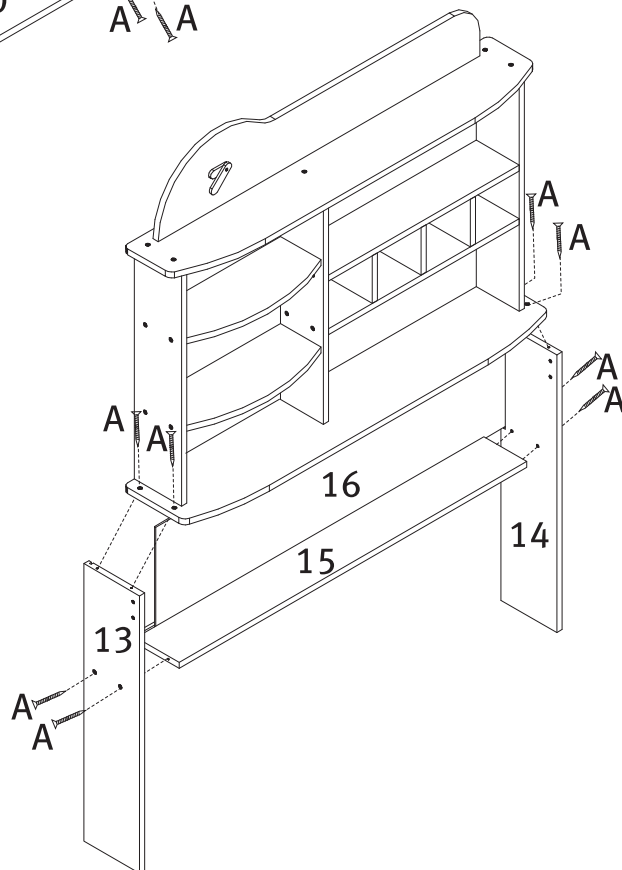

4

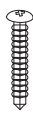

A	C	D	F
			
22x	4x	4x	4x

5

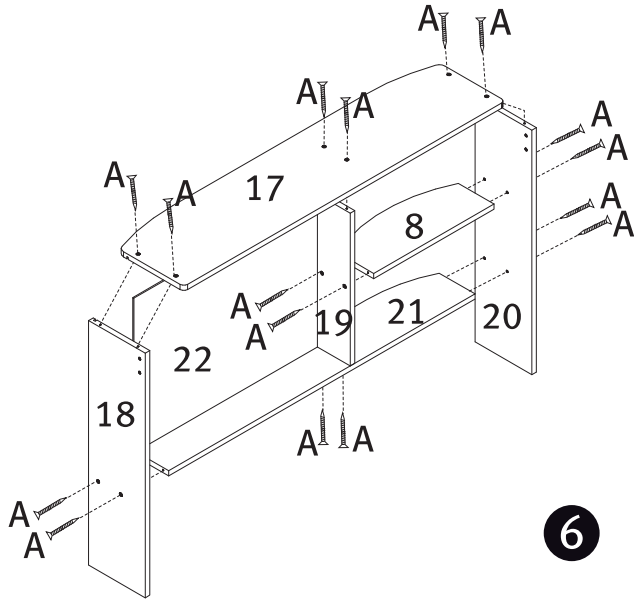

6

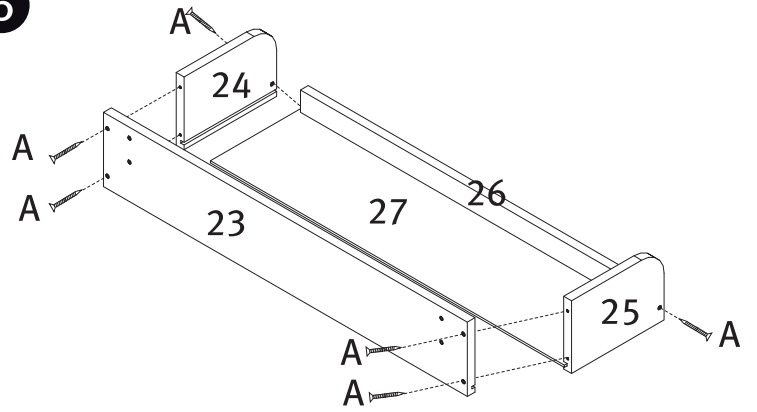

7

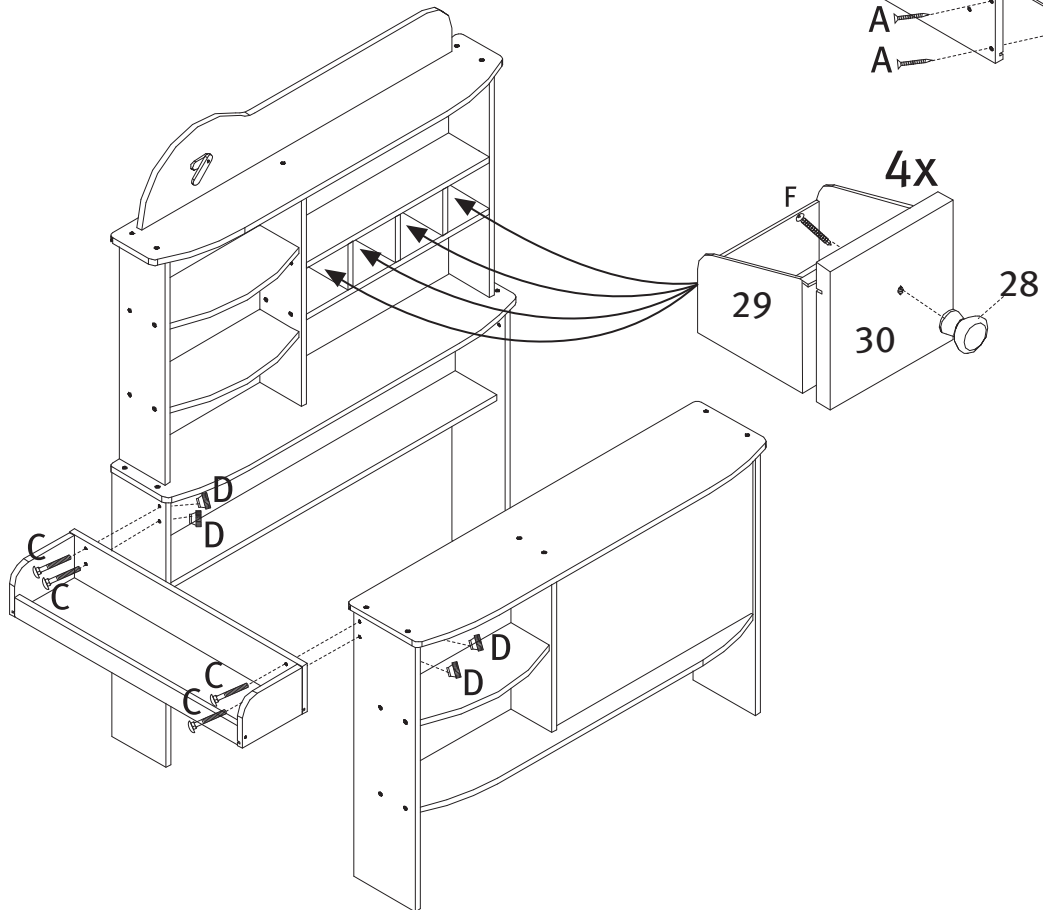

- DE Sicherheitshinweise**
- Achtung: Achten Sie darauf, dass Ihr Kind das Produkt nur in seiner vorgegebenen Funktion gebraucht und nicht zweckentfremdet!
  - Spielsachen müssen von Erwachsenen aufgebaut werden.

- UK Notes on safety**
- Attention: Make sure that your child is using the device only in its given function!
  - Toys must be assembled by an adult.

- FR Consignes de sécurité**
- Attention: Veillez à ce que votre enfant n'utilise le produit que dans sa fonction prescrite et ne s'en serve pas à d'autres fins!
  - Les jouets doivent être montés par des adultes.

- ES Instrucciones de seguridad**
- ¡Atención: Asegúrese de que su hijo utilice el producto únicamente para la función prescrita y no para otros usos!
  - Los juguetes deben ser montados por adultos.

- PT Instruções de segurança**
- Atenção: Certifique-se de que a criança utiliza o produto apenas para a função a que se destina e não para outros fins!
  - Os brinquedos devem ser montados por adultos.

- IT Informazioni di sicurezza**
- Attenzione: Faccia attenzione al fatto che il Suo bambino utilizzi il prodotto esclusivamente per la sua funzione prevista e non lo impieghi per un altro scopo!
  - I giocattoli devono essere montati da persone adulte.

- NL Veiligheidsinstructies**
- Opgelet: Let op dat uw kind het product uitsluitend voor de vastgestelde functie gebruikt en niet aan het eigenlijke gebruik onttrekt!
  - Speelgoed moet door volwassenen opgebouwd worden.

- DK Sikkerhedshenvisninger**
- Giv agt: Vær opmærksom på, at dit barn kun bruger artiklen hensigtsmæssigt og ikke bruger den til andet end det oprindelige formål!
  - Legetøj skal sammensættes af voksne.

- SE Säkerhetsinformation**
- OBS: Se till, att ditt barn endast använder produkten ändamålsenligt och inte för något annat!
  - Leksaker måste monteras av vuxna personer.

- FI Turvaohjeet**
- Huomio: Varmista, että lapsesi käyttää tuotetta vain sille tarkoitettuun toimintaan, eikä käytä sitä muuhun tarkoitukseen!
  - Aikuisten on koottava leikkikalut.

- NO Sikkerhetsanvisninger**
- Gi akt: Du skal passe på at barnet ditt bruker skrivetavlen kun til det som det er bestemt for og ikke til noe annet!
  - Leker skal monteres av voksne.

- PL Wskazówki bezpieczeństwa**
- Uwaga: Należy uważać, aby dziecko stosowało produkt wyłącznie zgodnie z jego przeznaczeniem, a nie do innych celów!
  - Zabawki muszą być montowane przez osoby dorosłe.

- CZ Bezpečnostní pokyny**
- Upozornění: Dbejte na to, aby dítě používalo výrobek jen k danému, nikoliv jinému účelu!
  - Hračky musí smontovat dospělá osoba.

- HU Biztonsági előírások**
- Figyelem: Ügyeljen rá, hogy a gyermeke csak az előre megadott célra használja a terméket, és másra ne fogja be!
  - Játékokat felőttnek kell összeállítania.

- HR Sigurnosne upute**
- Pozor: Obratite pozornost na to Vaše dijete proizvod koristi samo u svrhe za koje je namijenjen, a ne u druge svrhe!
  - Igračke moraju sastaviti odrasle osobe.

- RO Indicații de securitate**
- Atenție: Permiteți folosirea produsului de către copil numai în scopul pentru care este destinat și nu în alte scopuri!
  - Jucăriile trebuie asamblate de adulți.

- RS Sigurnosne upute**
- Pažnja: Vodite računa da vaše dete proizvod koristi samo u njegovoj predviđenoj funkciji, a ne suprotno nameni!
  - Igračke moraju da sastave odrasli.

- SK Bezpečnostné upozornenia**
- Pozor: Dbajte na to, aby dieťa výrobok používalo iba v súlade s jeho určením a nepoužívalo ho na iný účel!
  - Hračky musia zmontovať dospelí.

- SI Varnostna navodila**
- Pozor: Pazite na to, da bo otrok izdelek uporabljal le v skladu z njegovo namembnostjo in ne v druge namene!
  - Igrače morajo sestaviti odrasli.

- TR Güvenlik uyarıları**
- Dikkat: Çocuğunuzun ürünü amacından saptırmadan, sadece belirtilen fonksiyonu dâhilinde kullanmasına dikkat ediniz! Oyun eşyalarının yetişkinler tarafından kurulmaları gerekmektedir.
  - Oyuncaklar yetişkinler tarafından kurulmalıdır.

- GR Υποδείξεις ασφαλείας**
- Προσοχή: Να μεριμνάτε, ώστε να χρησιμοποιείτε το παιδί σας το προϊόν μόνο για τη λειτουργία που προβλέπεται κι όχι για άλλο σκοπό!
  - Η συναρμολόγηση και ανέγερση των παιχνιδιών πρέπει να γίνεται από ενήλικους.

- RU Информация по технике безопасности**
- Внимание! Следите за тем, чтобы детская кровать использовалась только по прямому назначению!
  - Сборка игрушек должна производиться только взрослыми!